

# Coal, Coke & Iron Ore Testing Furnaces

LEADING HEAT TECHNOLOGY





# SCIENCE FOR SOLIDS

**HEAT TREATMENT**  
**ELEMENTAL ANALYSIS**  
**MATERIALOGRAPHY &**  
**HARDNESS TESTING**  
**MILLING & SIEVING**  
**PARTICLE CHARACTERIZATION**

As part of the VERDER Group, the business division VERDER SCIENTIFIC sets standards in the development, manufacture and sales of laboratory and analytical equipment. The instruments are used in the areas of quality control, research and development for sample preparation and analysis of solids.

## Leading Heat Technology

The Carbolite Gero brand is synonymous with high quality, leading heat technology in the design and manufacture of laboratory and industrial ovens and furnaces ranging from 30°C to 3000°C and sold globally to over 100 countries.

On 1<sup>st</sup> January 2016 Carbolite (UK) and Carbolite Gero (Germany) joined to become one company under the name of Carbolite Gero. With the combined product lines the company will strengthen its market position locally and globally. In the past, both companies gained strong, established reputations for engineering expertise in applied heating technology.

Carbolite Gero has two manufacturing and sales sites. One is based in Derbyshire, United Kingdom, where Carbolite has been manufacturing laboratory and industrial ovens and furnaces up to 1800°C since 1938; the second facility is located in Neuhausen, southern Germany, where high temperature furnaces up to 3000°C with a large variety of solutions for vacuum and other modified atmospheres have been manufactured since 1982.

In addition to the wide range of standard products as shown in this catalogue, Carbolite Gero is an expert in the development of customized equipment for complex heat treatment processes. Solving customers' individual application requirements has given Carbolite Gero an important place in aerospace, engineering, materials science, heat treatment, medical, bioscience and contract testing laboratories globally to name a few. Not only can Carbolite Gero supply products with Standards-compliant furnace and oven designs (eg, Nadcap heat treatment processes (AMS2750F)), but also fully traceable certification for control, measurement, recording and data acquisition devices, issued by an independent UKAS accredited laboratory.

All products, and more, featured in this catalogue are available through your local Carbolite Gero office or an extensive network of dealers and local sales organisations.

[www.carbolite-gero.com](http://www.carbolite-gero.com)



## Icons used in this catalogue

Icons are displayed against products that feature these details



Qualitatively assesses.  
Test method is empirical.



Quantitatively measures.  
Test method is used to provide a measurement or value.



Moisture determination quantifies the amount of moisture in the material.



The content of a material that is liberated at high temperature in the absence of air (not including moisture).



Ashing removes all the content of the sample material that can be burnt in air, leaving behind non-combustible material.



Product incorporates zoned temperature control. The number represents the number of heated zones.



Product incorporates rotary motion.  
Example: tumbler for CSR (coke strength after reduction).

**CGH** Manufactured at Carbolite Gero Hope

**CGN** Manufactured at Carbolite Gero Neuhausen

## Contents

	Model	up to	Page
<b>Furnaces &amp; Ovens for Proximate Analysis</b>			
Minimum Free Space Oven	MFS/1	210°C	6
Coal Drying Ovens	CDLT / CDHT	200°C	7
Volatile Matter Furnaces	VMF	1000°C	8-9
Coal Ashing Furnaces	AAF	1100°C	10-11
<b>Furnaces &amp; Ovens for determination of coke reactivity, iron ore reducibility, ash fusibility, swelling number index, expansion and contraction of coal and coking properties</b>			
Swelling Number Index Furnace	SNF	900°C	12
Combustion Tube Furnaces	CFM	1400°C	13
Coal Ash Fusibility Furnace	CAF G5	1600°C	14-16
Single Sole Heated Oven	SHO	1000°C	17
Coke Reactivity Furnace	CRI	1100°C	18-19
Coke Strength after Reduction Tumbler	CSR	-	20
Fixed Wall Coke Test Oven	CTO 7	1300°C	21
Variable Width Moving Wall Coking Test Oven	MWO	1300°C	22-24
Gray King Coke Test Furnace	GK	600°C	25
Iron Ore Reducibility Furnace	IOR	1100°C	26-27
Iron Ore Tumbler	IOT	-	28
Coal Characterisation Pyrolysis Furnace	GLO	1100°C	29
Low Temperature Reduction – Disintegration of Iron Ore (ISO 13930: 2015)	LTD	1000°C	30-31
CO <sub>2</sub> Reactivity Test Furnace	CRF/1	1000°C	32
<b>International Standards Summary</b>			<b>33</b>
<b>Index</b>			<b>34</b>
<b>Optional Part Specifications and Item Numbers</b>			<b>34</b>



## Carbolite Gero's expertise in coal, coke and iron ore testing

The characterisation of coal is important for its quality assessment. The most common types of coal (lignite, bituminous and anthracite) can be distinguished by their different chemical and physical properties. Depending on the product quality, coal is suitable for a variety of uses including coking, steel production and power generation.

The formation of coal from a variety of plant materials via biochemical and geochemical processes is called coalification. The nature of the constituents in coal is related to the degree of coalification, the measurement of which is termed rank. Rank is usually assessed by a series of tests, collectively called proximate analysis, that determine the moisture content, volatile matter content, ash content, fixed-carbon content, and calorific value.

Carbolite Gero has developed a range of coal and coke testing furnaces and ovens for proximate analysis to qualitatively assess or, quantitatively measure, the amount of moisture, ash, volatile matter and fixed carbon in coal samples. Other products are also available for the determination of coke reactivity, iron ore reducibility, ash fusibility, swelling number index, expansion and contraction of coal and caking properties.

The range of coal and coke tests carried out in a furnace or oven has grown over many years, and Carbolite Gero has responded to the requirements of each new standard by

designing a product to suit the specific requirements of each test method.

The range includes bench top laboratory models for routine testing and large pilot plant scale products, some of which are unique to Carbolite Gero, such as the variable width hearth moving wall coking oven which can be found in coal research facilities as well as large steel producing plants around the world.

Retsch GmbH, within the Verder Scientific group, offers a range of products for sample preparation of all types of coal whilst Retsch Technology products are suitable for the characterization of coal-related products.

Also within the Verder Scientific Group, Eltra GmbH offers a range of equipment for elemental analysis ([www.eltra.com](http://www.eltra.com)).

Carbolite Gero operates a stringent quality management system and is ISO 9001 accredited. All products carry the CE mark indicating compliance with all relevant European safety directives, ie, machinery directive, low voltage directive and electromagnetic compatibility directive. The Carbolite Gero range of products meets the requirements of the relevant international ISO, ASTM, EN, BS, and DIN test methods. See page 33.

**For further information on all Carbolite Gero coal and coke products enquire at [info@carbolite-gero.com](mailto:info@carbolite-gero.com).**

### Disclaimer

As Carbolite Gero has a policy of continuous product development, improvements and changes will be made during the lifetime of this catalogue. Carbolite Gero reserves the

right to amend the specifications at any time and in any particular way without prior notice provided that the ultimate performance of the equipment is not reduced by such action.

If the dimensions or technical specification of a product in this catalogue are critical, it is important that Carbolite Gero is contacted to confirm the details prior to order placement.





## MFS/1 – Minimum Free Space Oven

**From its natural development to its processing, coal contains an amount of moisture which needs to be quantified.**

One method of quantifying moisture in coal is by measuring the weight loss of a sample after drying. The MFS is used for this drying process and has a small heated chamber to provide the lowest practical volume, ie, minimum free space, as required by the test standards. A known mass of the coal is heated in a stream of nitrogen or air at a temperature between 105°C and 110°C and maintained at this temperature until its mass is constant. The moisture content is calculated from the loss in mass of the coal.

The ovens have a corrosion and oxidation resistant aluminium chamber which provides good temperature uniformity. The nitrogen or air flow can be adjusted by a flow meter fitted on the control panel and passes through a pre-heating chamber before entering the front of the work chamber.

The MFS/1 ISO operates with a regulated flow of moisture-free bottled nitrogen which removes the moisture released by the coal at 105°C. The MFS/1 ASTM operates with a regulated flow of air.



MFS/1

### Options (specify these at time of order)

- Welded steel desiccator with provision for a nitrogen flow which is used as a cooling vessel. The crucibles can be transferred directly into the desiccator without the need for cooling on a metal plate.
- Models available for alternative mains supply voltages
- Over-temperature control
- Crucibles with well-fitting covers



Optional desiccator



Aluminium loading tray showing optional crucibles with well-fitting covers. The maximum number of crucibles per tray is 15.

Standard	Description	Suitable oven	
<b>BS ISO 687:2010</b>	Solid mineral fuels - Coke - Determination of moisture in the general analysis test sample	MFS/1 ISO	-
<b>BS ISO 11722:2013</b>	Solid mineral fuels - Hard coal - Determination of moisture in the general analysis test sample by drying in nitrogen	MFS/1 ISO	-
<b>ASTM D3173-11</b>	Standard Test Method for Moisture in the Analysis Sample of Coal and Coke	-	MFS/1 ASTM



### Standard features

- 210°C maximum operating temperature
- 2132 controller fitted as standard
- Loading tray
- Flow meters to monitor gas flow & chamber seal integrity

### Options part numbers

Option	Item number
Desiccator for MFS	MFS DESICCATOR
Silica crucibles	40-209-460-0050
Aluminium crucible lids	40-209-100-0010
Crucible kit (crucible and lid)	MFS-CRUC-KIT
Additional trays	00047-4-1532-SP

## Technical data

CGH	Meter type	Max. operating temp. [°C]	Chamber dimensions H x W x D [mm]	External dimensions H x W x D [mm]	**Temperature uniformity [°C @ 210°C]	Temperature stability [°C]	Volume [litres]	Max. power [W]
<b>MFS/1 ISO</b>	Nitrogen	210	25* x 195 x 290	185 x 490 x 450	±0.5	±0.5	1.4	500
<b>MFS/1 ASTM</b>	Air	210	25* x 195 x 290	185 x 490 x 450	±0.5	±0.5	1.4	500

\* reduced to 22 mm below the thermocouple

\*\* uniformity is measured in an empty chamber after a stabilisation period



## CD range – Coal Drying Ovens (CDLT & CDHT)

The measurement of total moisture is required to determine whether coal meets commercial or environmental specifications, or both. Since coal can vary from extremely wet to completely dry, special emphasis must be placed on the sampling, sample preparation and the moisture determination itself to ensure total reliability of measurement.

The Carbolite Gero coal drying range of ovens consists of the CDHT (Coal Drying High Temperature) with a normal operating temperature of 105°C and CDLT (Coal Drying Low Temperature) with a normal operating temperature of 30°C, both being suitable for drying coal in accordance with the Standards listed on the right.

Air is circulated around the oven by two centrifugal fans. Ducts and air-guides ensure that the airflow is horizontal across the chamber with air being directed over each of the seven tray levels. Adjustable inlet and outlet vents are provided so that the warm moist air is ventilated to atmosphere and replenished with fresh air. The incoming air is pre-heated before it enters the work chamber. The maximum rate of ventilation is 3 volume changes per minute.



The sample in the oven is heated and maintained at a specified temperature until constant in mass. The moisture percentage is calculated from the loss in mass of the sample. Coke is not liable to oxidation under the specified conditions.



### Standard features

- 200°C maximum operating temperature (CDHT)
- 50°C maximum operating temperature (CDLT)
- 2132 controller fitted as standard
- A high rate of horizontal airflow is directed over each of the seven tray levels
- Air inlets and outlets sited to vent out moist air and replace with fresh air
- Incoming air is pre-heated before entering the chamber
- Secondary 2132 over-temperature control
- Complete with integral floor stand
- Chamber and air guides constructed from corrosion and oxidation resistant grade 304 stainless steel
- Reliable and long lasting mineral insulated, metal sheathed elements

Standard	Description	Suitable oven	
<b>BS ISO 13909-1:2016</b>	Methods for analysis and testing of coal and coke. Total moisture of coal	CDHT	CDLT
<b>BS ISO 13909-2:2016</b>	Hard coal and coke. Mechanical sampling. Coal. Sampling from moving streams	CDHT	CDLT
<b>BS 1016-1:1973</b>	Methods for analysis and testing of coal and coke. Total moisture of coal	CDHT	CDLT
<b>BS ISO 579:2013</b>	Coke. Determination of total moisture	CDHT	CDLT
<b>ASTM D2961-11</b>	Standard Test Method for Single-Stage Total Moisture Less than 15% in Coal	CDHT	-
<b>ASTM D2013/D2013M-12</b>	Standard Practice for Preparing Coal Samples for Analysis	-	CDLT
<b>ASTM D3302</b>	Standard Test Method for Total Moisture in Coal	-	CDLT

## Technical data

CGH Model	Max. operating temp. [°C]	Internal dimensions H x W x D [mm]	External dimensions H x W x D [mm]	No. of trays / levels	Temperature stability [°C]	Temperature uniformity [°C]	Volume [litres]	Max. power [W]
<b>CDLT</b>	50	610 x 610 x 1220	1715 x 1345 x 1455 (including integral floor stand)	14 / 7	±1	±5	454	4500
<b>CDHT</b>	200	610 x 610 x 1220	1715 x 1345 x 1455 (including integral floor stand)	14 / 7	±1	±5	454	9000

**i** Please note:  
- Uniformity is measured in an empty chamber with vents closed, after a stabilisation period



## VMF – Volatile Matter Furnaces

**Volatile matter in coal, ie, the matter given off before oxidation, refers to the volatile components of coal, except moisture, which are removed at high temperature in the absence of air. This is usually a mixture of short and long chain hydrocarbons, aromatic hydrocarbons and some sulphur.**

Volatile matter is determined as the loss in mass, less that due to moisture, when coal or coke is heated out of contact with air under standardised conditions. The test is empirical and, in order to ensure reproducible results, it is essential that the rate of heating, the final temperature and the overall duration of the test be carefully controlled. It is also essential to exclude air from the coal or coke during heating to prevent oxidation. The fit of the crucible lid is, therefore, critical.

The moisture content of the sample must be determined at the same time as the volatile matter so that the appropriate correction can be made.

The Carbolite Gero VMF furnaces are specifically designed for testing the volatile matter of coal and meet the test methods of International Standards:

Furnace	Standard	Description
VMF 10/6	BS ISO 562:2010	Hard coal and coke – determination of volatile matter
VMF/ASTM	ASTM D3175-20	Standard test method for volatile matter in the analysis sample of coal and coke

## VMF 10/6 (BS ISO 562:2010) – ‘Hard coal and coke – Determination of volatile matter’

This test method determines the volatile matter of hard coal and of coke. It is not applicable to brown coals and lignites. A portion of the sample is heated out of contact with air at 900°C for 7 minutes. The percentage mass fraction of volatile matter is calculated from the loss in mass of the test portion after deducting the loss in mass due to moisture. The VMF 10/6 offers temperature and response times to meet the requirements of BS ISO 562:2010.



### Standard features

- 1000°C maximum operating temperature
- 2132 controller fitted as standard
- Fast heating - typically 20 mins to 900°C. Open spiral elements located in the chamber roof and under the hearth supported in low thermal mass insulation ensure the rapid heating required by the Standard
- Fast recovery of temperature after loading samples – less than 4 mins to return to 900°C ± 5°C
- Chimney at back of the chamber
- Hardwearing refractory bricks in chamber entrance for resistance to abrasion
- Calibration ports allow insertion of unshathed probe thermocouples from the back of the chamber as required by the standard
- Suits crucibles measuring 21 mm id / 25 mm od x 38 mm high and close fitting lid



VMF 10/6 (ISO)



### Options (specify these at time of order)

- 4 or 9 crucible stand
- Loading handle
- Crucibles and lids
- Digital communications or paperless nanodac recorder for documentary evidence of test procedure
- Over-temperature control



Options part numbers

Option	Item number
Crucible & lid	40-209-460-0025
4 crucible stand	00037-3-2003
9 crucible stand	00037-3-2004
Crucible stand handle	00125-3-1007



Optional Crucible with lid (VMF 10/6)



Optional 4 crucible stand + 4 crucibles with lids (VMF 10/6)

## VMF / ASTM (ASTM D3175-20) – 'Standard Test Method for Volatile Matter in the Analysis Sample of Coal and Coke'

This test method determines the percentage of gaseous products, exclusive of moisture vapour, in the analysis sample which are released under the specific conditions of the test. As the test is empirical strict adherence to basic principles and permissible procedures is required to obtain valid results.



### Standard features

- 1000 °C maximum operating temperature
- 2132 controller fitted as standard
- Top loading 50 mm diameter x 100 mm deep with hinged lid
- Corrosion and oxidation resistant Inconel crucible & lid
- Crucible holder included as standard
- 30 mA (RCD) residual current device, for additional protection



VMF / ASTM



### Options (specify these at time of order)

- Over-temperature protection



Corrosion and oxidation resistant Inconel crucible & lid (VMF/ASTM)



Standard wire crucible holder shown with crucible & lid (VMF/ASTM)

Options part numbers

Option	Item number
Inconel crucible & lid (VMF/ASTM)	40-209-010-0020
Wire crucible holder (VMF/ASTM)	00329-3-2001

## Technical data

CGH	Max. operating temp. [°C]	Continuous operating temp. [°C]	Heat-up time to 900 °C [mins]	Internal dimensions H x W x D / Ø x D [mm]	External dimensions H x W x D [mm]	Number of samples	Thermocouple type	Max. power [W]	Weight [kg]
<b>VMF 10/6 (ISO)</b>	1000	950	20	100 x 210 x 260	655 x 435 x 260	1, 4 or 9	K	3000	47
<b>VMF/ASTM</b>	1000	1000	20	50 x 100	330 x 410 x 300	1	N	950	9

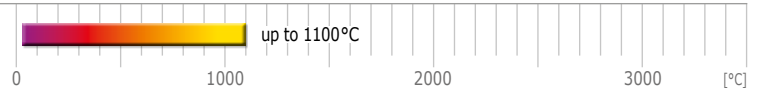

## AAF – Coal Ashing Furnaces

**The ashing process determines the amount of ash-forming material present in a petroleum product to enable a decision on its use in certain applications. Ash-forming materials are considered to be undesirable impurities or contaminants.**

The ash remaining after coal or coke has been incinerated in air is derived from inorganic complexes present in the original coal substance and from associated mineral matter. The amount of sulphur retained in the ash is in part dependent on the conditions of ashing and, in order to obtain values for the ash on a comparable basis, it is necessary to adhere strictly to the conditions specified in the standards. BS ISO 1171:2010 specifies a method for the determination of the ash of all solid mineral fuels and ASTM D3174-12 specifies the test method for ash in an analysis sample of coal and coke.

The process involves heating the test portion in air at a specified rate up to a temperature of  $815^{\circ}\text{C} \pm 10^{\circ}\text{C}$  and maintaining it at this temperature until constant in mass. The ash percentage is calculated from the mass of the residue after incineration.

The range of Carbolite Gero AAF ashing furnaces complies with the standards above and are specifically designed to provide optimum ashing conditions to ensure complete combustion of the sample. The AAF 11/3 and AAF 11/7 have large floor areas which allow many samples to be accommodated. They are supplied with a corrosion and



AAF 11/3 and AAF 11/7

oxidisation resistant Inconel tray (maximum temperature  $1100^{\circ}\text{C}$ ) complete with loading handle. The low chamber height ensures the air flow is held close over the samples to promote burning. The traditional muffle heated chamber is extremely durable, giving good resistance to abrasion and to vapour attack. The chamber provides heating on all four sides from wire elements which are wrapped around the outside of the chamber liner for protection. Good air flow is ensured by natural convection through a tall chimney and provides 4-5 volume air changes per minute. The incoming air is preheated before it enters the heated chamber ensuring that crucibles located near the inlet are not chilled.

### Standard features

- $1100^{\circ}\text{C}$  maximum operating temperatures
- Carbolite Gero 301 single ramp to setpoint controller & process timer
- Large floor area allows for large number of samples
- Wire elements are protected from chemical & mechanical damage by a hard wearing alumina based liner
- Air inlet & tall chimney provide 4 to 5 volume air changes per minute
- Low chamber height holds airflow close to samples for optimum combustion
- Powerful elements with graded winding compensate for heat losses
- Preheating of air before it enters the chamber gives excellent uniformity
- Corrosion and oxidisation resistant Inconel sample tray and loading handle

### Options (specify these at time of order)

- 2 phase electrical supply for AAF 11/7
- Over-temperature protection (recommended to protect valuable contents & for unattended operation)
- Control Options
  - 301 Standard Controllers
  - 3216 Programmable Controllers
  - 3508 Programmable Controllers
- Crucibles
- Crucible lid - required during cooling (ASTM D3174)

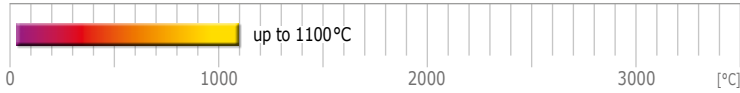

Optional crucibles and lids



Corrosion and oxidation resistant Inconel sample trays and handle supplied as standard



Standard corrosion and oxidation resistant Inconel tray with optional crucibles

Options part numbers

Option	Item number
Fused silica crucible	40-209-460-0050
Aluminium crucible lid (as required in ASTM D3174-12)	40-209-100-0010
Crucible kit (crucible & lid)	AAF-CRUC-KIT
AAF 11/3 tray, dimensions inside W = 133 mm, D = 210 mm	00167-3-2051
AAF 11/7 tray, dimensions inside W = 163 mm, D = 330 mm	00167-3-2054
Additional tray loading handle	00125-3-1007

Airflow in AAF 11/3 and AAF 11/7:

- 1) A tall chimney pulls the air through the chamber - 35 mm diameter on AAF 11/3 and 50 mm diameter on AAF 11/7
- 2) Preheated air enters the chamber after circulating around the outside of the chamber
- 3) Air inlet

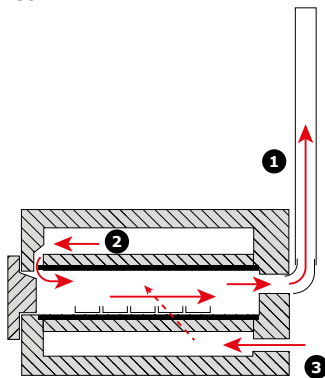

Technical data

CGH	Max. temp. [°C]	Heat-up time [mins]	Max. continuous operating temp. [°C]	Dimensions: Internal H x W x D [mm]	Dimensions: External H x W x D [mm]	Dimensions: External with door open H x W x D [mm]	Dimensions: Height to top chimney [mm]	Volume [litres]	Max. power [W]	Holding power [W]	Thermocouple type	Weight [kg]
AAF 11/3	1100	155	1000	90 x 150 x 250	585 x 375 x 485	800 x 375 x 485	780	3	2100	1270	K	22
AAF 11/7	1100	155	1000	90 x 170 x 455	650 x 430 x 740	905 x 430 x 740	1060	7	4000	2624	K	63

**i** Please note:  
 - Holding power is measured at 500°C  
 - Heat up time is measured to 100°C below max, using an empty chamber

- Maximum power and heat up time based on a 240 V supply



## SNF – Swelling Number Index Furnace

**A swelling number is defined by reference to a series of standard profiles, the size and shape of the residue obtained when a specified mass of coal is heated in a covered crucible under specified conditions.**

The Carbolite Gero swelling number index furnace is designed to test the swelling index number of coal in accordance with the following Standards:

Standard	Description
<b>BS ISO 501:2012</b>	Hard Coal – Determination of the crucible swelling number.
<b>ASTM D720-15</b>	Standard Test Method for Free-Swelling Index of Coal.

The small scale free swelling index test is used to evaluate to what extent a coal will swell during coking, thereby helping to assess whether the coal is suitable for the production of coke and the amount necessary to fill the production plant. This involves heating a small sample of coal in a covered crucible to 800 °C.

The shape of the coke button obtained is classified by comparison with the outlines of a set of standard profiles. The results may be used as an indication of the caking characteristic of the coal when burned as a fuel.



### Standard features

- Maximum operating temperature 900 °C
- 2132 controller fitted as standard
- Top loading 55 mm diameter design x 85 mm deep with hinged lid
- 30 mA (RCD) residual current device, for additional protection
- Crucible, lid and holder
- Calibration kit



SNF with Calibration Kit



SNF

### Options (specify these at time of order)

- A range of temperature controllers
- Over-temperature protection (recommended)
- Crucible lid with hole (for calibration)



Silica crucible & lid with hole (optional) used for calibration



Wire crucible holder (standard) with crucible and lid (optional)

### Options part numbers

Option	Item number
Crucible lid with diameter 6 mm hole (used for calibration)	40-209-460-0035
Additional crucible holder	00057-3-2006
Additional crucible kit (crucible & lid - without hole)	SNF-CRUCIBLE-K

### SNF cross section

- 1) Crucible holder
- 2) Crucible
- 3) Hinged lid
- 4) Heating elements
- 5) Control thermocouple

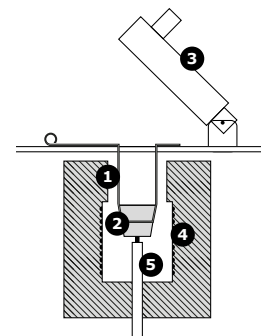

## Technical data

CGH	Max. temp. [°C]	Max. continuous operating temp. [°C]	External dimensions H x W x D [mm]	Crucible dimensions H x W x Ø at base [mm]	Crucible volume [ml]	Thermocouple type	Max. power [W]
<b>SNF</b>	900	850	330 x 410 x 300	26 x 41 x 11	17	K	900

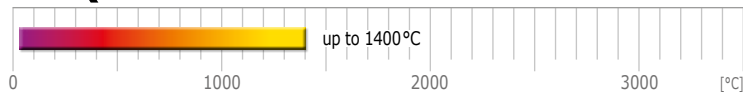

## CFM – Combustion Tube Furnaces

The Carbolite Gero combustion tube furnace has been specifically designed for determining the quantity of carbon, hydrogen and sulphur in the analysis sample of coal and coke using test methods in accordance with the following standards:

Standard	Description
----------	-------------

### Standards to test for Carbon, Hydrogen & Sulphur

<b>BS 1016-106.1.1:1996</b>	Methods for analysis and testing of coal and coke. Ultimate analysis of coal and coke.
<b>ISO 609:1996</b>	Solid mineral fuels – Determination of carbon and hydrogen.

### Standards to test for Sulphur

<b>ASTM D4239</b>	Standard Test Methods for Total Sulphur in the Analysis Sample of Coal and Coke using high temperature tube furnace combustion
<b>BS1016-106.4.2:1996</b>	Solid mineral fuels – Determination of total sulphur – High temperature combustion method



CFM 14/2

The CFM is available with maximum operating temperatures up to 1200°C (CFM 12) and 1400°C (CFM 14) and is also ideal for a wide range of laboratory tube furnace applications.

The CFM 14/AUX models include an auxiliary heater for carbon and hydrogen tests in line with international standards BS 1016-6 & 7:1977 (above).

The AUX models are used to heat a silver gauze roll for the retention of oxides of sulphur.

### Options (specify these at time of order)

- IAP tubes – dimensions 25 id x 32 od x 750 mm  
Part Number: TU-IAP-025-0750
- Over-temperature protection



### Standard features

- Maximum operating temperatures 1200°C and 1400°C
- 301 single ramp PID controller
- For the determination of sulphur, chlorine, hydrogen and carbon in coal and coke
- AUX models use an auxiliary heater to heat the silver gauze portion of the tube

## Technical data

CGH Model	Max. temp. [°C]	Max. continuous operating temp. [°C]	Heated tube length [mm]	Number of tubes	External dimensions H x W x D [mm]	Max. outer diameter accessory tube [mm]	Fixed tube inner diameter [mm]	Max. power [W]
<b>CFM 12/1</b>	1200	1100	300	1	526 x 422 x 363	38	38	950
<b>CFM 12/2</b>	1200	1100	300	2	526 x 422 x 363	38	38	1800
<b>CFM 14/1</b>	1400	1350	180	1	526 x 422 x 363	32	38	2250
<b>CFM 14/2</b>	1400	1350	180	2	526 x 422 x 363	32	38	2250
<b>CFM 14/1 AUX</b>	1400	1350	180	1	526 x 422 x 363	32	38	2333
<b>CFM 14/2 AUX</b>	1400	1350	180	2	526 x 422 x 363	32	38	2333

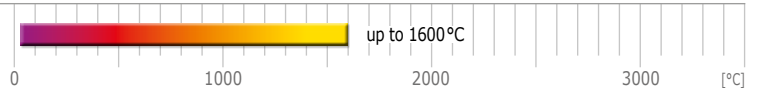

## CAF G5 – Coal Ash Fusibility Furnace

Coal ash is the non-combustible waste material left after coal is burned. The heat from the burning of the coal melts the coal ash which, when cool forms 'clinker', a stony residue from burnt coal. Large coal furnaces suffer from clinker build-up which can result in the closure of the furnace to allow removal. If the fusibility characteristics of the coal ash are known, control of the temperature can avoid clinker formation.



CAF G5

NEW



Ash melting is a complex process where shrinkage, sintering and swelling can occur. The test method covers the observation of the temperatures at which the ash melting behaviour of coal and coke ash conforms to the below Standards:

Standard	Description
<b>DIN 51730:2007-09</b>	Testing of solid fuels — Determination of fusibility of fuel ash
<b>BS ISO 540:2008</b>	Hard coal and coke - Determination of ash fusibility
<b>ASTM D1857 / D1857M - 18</b>	Standard Test Method for Fusibility of Coal and Coke Ash
<b>DD CEN/TS 15370-1 : 2006</b>	Solid biofuels. Method for the determination of ash melting behaviour. Characteristic temperatures method
<b>PD CEN/TR 15404 : 2010</b>	Solid recovered fuels (SRF). Methods for the determination of ash melting behaviour by using characteristic temperatures

A test piece made from ash is heated under standard conditions and continuously observed. The temperatures at which characteristic changes of shape occur are recorded. The characteristic coal ash temperatures are defined as deformation, sphere, hemisphere and flow. Although the deformation is usually performed in a reducing atmosphere, additional information can sometimes be obtained by performing a further determination in an oxidising atmosphere.

With a maximum operating temperature of 1600°C the Carbolite Gero CAF G5 is designed to test coal ash fusibility and, optionally, the increasingly popular determination of biomass ash or solid recovered fuels (SRF) ash conforming to the above Standards.

A large diameter work tube ensures that only one furnace is required to analyse more than six test pieces simultaneously. The furnace's efficient heating and cooling rates allow up to three tests per day to be completed.

### Standard features

- Maximum operating temperature 1600°C enabling biomass, SRF & coal ash testing
- Automatic and continuous recording of digital images
- Analysis software which can be used in semi automatic or manual modes
- Software zoom function to enable accurate post-test analysis of individual samples with improved resolution
- One configurable grid assigned to each test piece
- Temperature controller program set up within the software
- Space saving embedded computer with Windows 7 Embedded Professional software runs future-proof firmware
- Default software settings and individual analysis form for coal ash, biomass and SRF
- Low thermal mass insulation allows quick cooling permitting multiple tests to be completed during the day
- Automated digital image capture of samples. The frequency of images recorded is set by customer preference, from every 1°C increment to every 20°C

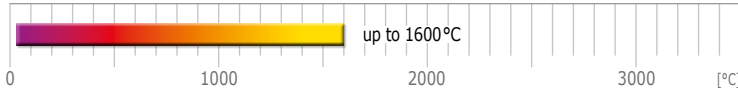

## Auto Analysis Software

The CAF G5 includes a new software package which offers the choice of automatic or manual analysis of samples. The sample profiles are identified by individual grids for each test piece. When using the automatic analysis option the software identifies the four melt point profiles as defined in the coal ash, biomass and SRF standards and creates graphical data of the various form factors including height, width, area, circumference, shape factor ratio and height/width ratio. The user can select which data from these factors they want to show on the graph. The software automatically populates the results table and stores the deformation point images (SST, DT, HT, FT – Biomass & SRF ash) (IDT, ST, HT, FT – coal ash) and offers a printed report function.

Stages of Melt Points – Coal ash

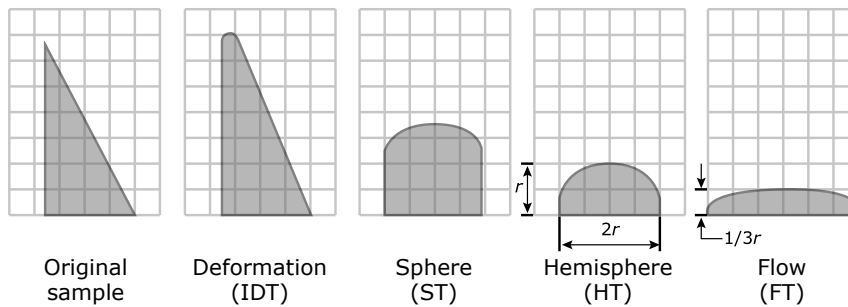

Stages of Melt Points – Biomass ash

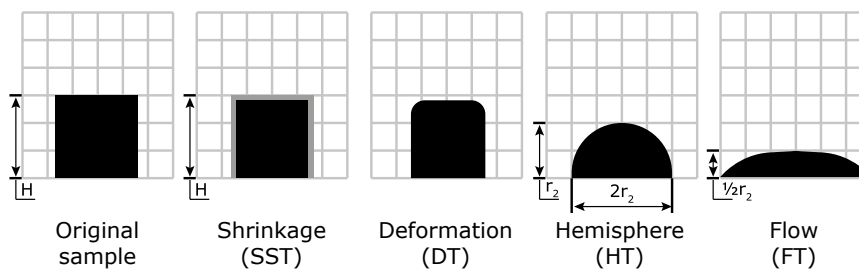

## Accurate digital image recording

The digital camera, mounted externally on the door, is simple to use, easy to access and can be quickly adjusted to different positions. Its automated and continuous high resolution images of the samples' four melt points are captured at temperature intervals set by customer preference with the computer software. The image capture rate can be set in increments from every 1°C to every 20°C. The maximum interval for auto analysis is 5°C. Multiple images are stored on an embedded computer in sequence including date, time, a batch identifier and the temperature at the point of capture. The automatic and continuous recording of digital images allows laboratory technicians to carry out other tasks while the test is in progress, reviewing results later.

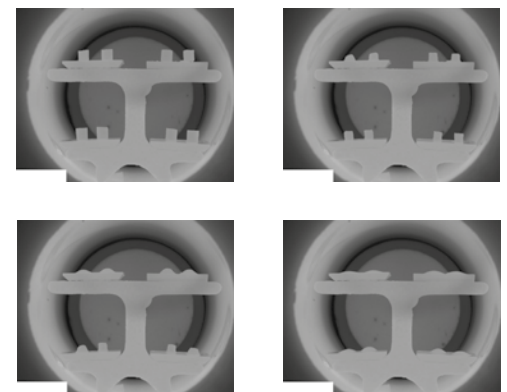

Example images taken from a typical test run

## Image grid assistance

A grid overlay feature is provided within the software for each sample (more than 6 samples can be simultaneously tested). The grids are positioned to identify the samples for automatic analysis or are used to assist manual analysis. They ensure accurate comparison of the height and width of the sample melt points. The position and scale of each grid is easily adjustable. Figure (a) shows a zoomed image of two samples with analysis grids in position.

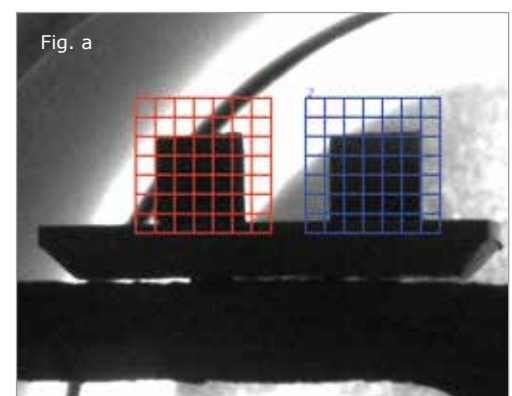

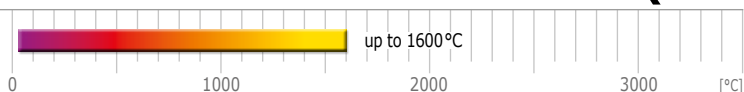

## CAF G5 – Coal Ash Fusibility Furnace

### Options (specify these at time of order)

- Work tube integrated lighting system when testing low 'initial deformation' temperature of biomass or SRF samples;
- Gas mix module (CO/CO<sub>2</sub>), Part Number: 00254-3-4024

#### Options part numbers

Option	Item number
Sample carrier	00254-3-2026
Samples tiles (100 pack)	CAF-TILE-KIT
Sample loading tool	00254-3-1003
Test piece mould (coal ash)	01517-3-2097
Test piece mould and hand press (biomass & SRF)	00254-3-4053
External mounting proprietary CO alarm	80-250-000-0010



## Gas Options

All CAF G5 furnaces can be run in reducing or oxidizing gas mode but due to the two different sets of gases the furnace is constructed specifically for the gases that are to be used to the Standard. Maximum gas pressure 276 mbar (4 psi).

Ash Material	Test standard	Reducing Gas	Oxidizing Gas	Purge Gas
Coal & Coke	ASTM D 1857-04	CO + CO <sub>2</sub>	Air	N <sub>2</sub>
Coal & Coke	BS ISO 540:2008 & DIN 51730:2007-09	CO + CO <sub>2</sub> or H <sub>2</sub> + CO <sub>2</sub>	Air or CO <sub>2</sub>	N <sub>2</sub> or CO <sub>2</sub>
Solid Recovered Fuels	PD CEN/TR 15404:2010	CO + CO <sub>2</sub>	Air	N <sub>2</sub>
Biomass	DD CEN/TS 15370-1:2006	CO + CO <sub>2</sub>	Air	N <sub>2</sub>

## Technical data

<b>Temperature Range</b>	Up to 1600°C (1600°C required for some biomass samples)	<b>Gas Requirements</b>	(Specific gas choice must be made at time of ordering, see item numbers below)
<b>Temperature Precision</b>	± 3°C above 800°C	Purge	N <sub>2</sub> or CO <sub>2</sub>
<b>Temperature Ramp Rate</b>	7°C per minute	Oxidising	O <sub>2</sub> or Air
<b>Temperature Control</b>	Digital multiple PID terms with gain scheduling and multi offset parameters	Reducing	CO + CO <sub>2</sub> or H <sub>2</sub> + CO <sub>2</sub>
<b>Temperature Display</b>	°C	<b>Ventilation</b>	Forced air ventilation
<b>Work Tube dimensions</b>	79 mm internal diameter	<b>Exhaust</b>	Pipe to be vented into a separate fume hood
<b>Tube material</b>	Mullite	<b>Safety</b>	Fail safe gas system and CO alarm supplied
<b>Heating Elements</b>	Silicon carbide x 6	<b>Physical Dimensions (mm)</b>	790 (h) x 505 (w) x 765 (case depth) x 970 (overall depth)
<b>Maximum Sample Load</b>	8	<b>Weight (kg)(furnace)</b>	84
<b>Conforms to Standards</b>	BS ISO 540:2008; ASTM D 1857/D1857M-04 (2010); DD CEN/TS 15370-1:2006; PD CEN/TR 15404:2010	<b>Power supply</b>	380–415 V, 50/60 Hz two phase 25 A/phase or 220–240 V, 50/60 Hz single phase 50 A
<b>Ash Fusibility Determination</b>	Automatic or Manual (Coal & coke: DT, ST, H, FT) (Biomass / SRF: IST, DT, HT, FT)	<b>Power switching</b>	Solid state relays
<b>Analysis Time</b>	3 runs per working day (including cool down times)	<b>Maximum power consumption (W)</b>	7000
<b>Image Collection</b>	Digital – up to 1 frame per 1°C rise in temperature	<b>Environment Conditions</b>	Operating Conditions 5°C–40°C Relative Humidity maximum 80% up to 31°C decreasing linearly to 50% at 40°C
<b>Image Resolution</b>	1280 x 1024 pixels	<b>Overtemperature protection</b>	Digital with single high alarm relay

Item Number	Description	illumination	Gases
CAFG5-BIO-220	CAF G5 BIOMASS 220–240 V 1-PH	yes	COCO <sub>2</sub> +AIR
CAFG5-BIO-380Z	CAF G5 BIOMASS 380–415 V 2PH+N	yes	COCO <sub>2</sub> +AIR
CAFG5-CO-220	CAF G5 COCO <sub>2</sub> +AIR 220–240 V 1-PH	no	COCO <sub>2</sub> +AIR
CAFG5-CO-380Z	CAF G5 COCO <sub>2</sub> +AIR 380–415 V 2PH+N	no	COCO <sub>2</sub> +AIR
CAFG5-H2-220	CAF G5 H <sub>2</sub> +CO <sub>2</sub> 220–240 V 1PH	no	H <sub>2</sub> +CO <sub>2</sub>
CAFG5-H2-380Z	CAF G5 H <sub>2</sub> +CO <sub>2</sub> 380–415 V 2PH+N	no	H <sub>2</sub> +CO <sub>2</sub>



## SHO – Single Sole Heated Oven

The Carbolite Gero single sole heated oven is used for measurement of the expansion or contraction of coal blends during carbonisation.

The oven has been designed in accordance with the Standard ASTM D 2014 – 97 'Expansion or Contraction of Coal by the Sole Heated Oven'. This test method covers a large-scale laboratory test for obtaining information on the expansion or contraction of coal, or coal blends, during carbonisation under specified conditions and is applicable in the examination of coals or coal blends intended for use in the production of coke.

A thickness of coal is heated uni-directionally from the bottom surface (known as the sole) in a carbonisation chamber while a constant force is applied to the top surface. Upon completion of the test, the thickness of coke is measured by a suitable probe. The values obtained in the test method indicate to what extent a given coal, or coal blend, will expand or contract during the carbonisation process when evaluated in terms of pertinent experience with other coals and coal blends and processing conditions used in commercial type coke ovens.

The Carbolite Gero single sole heated oven has a single loading piston mounted on a steel frame and is pivoted to give clear access to the chamber. The force from the cylinder is transmitted to the sample via a cast refractory block backed by a steel structure. A hydraulic cylinder provides the static load and a pressure regulator ensures that approximately 15.2 kPa is maintained throughout the carbonisation test.

The instrumentation and associated power control equipment are housed within a separate floor standing control cabinet which is linked to the oven with 3 m of cable and suitable trunking.



Single Sole Heated Oven

The single sole heated oven meets the temperature requirements specified below:

Time after initial setpoint of 554°C achieved [h]	Temperature [°C]
0.00	554
1.00	585
2.00	777
3.00	840
4.00	869
5.00	921
6.00	943
7.00	950
From then on	950



### Standard features

- Maximum operating temperature 1000 °C
- 3504P1 controller
- Eurotherm graphic data logger
- A bottom opening loading device
- Coal levelling device
- Over-temperature control



Bottom opening loading device



Coal levelling device

## Technical data

CGH Model	Max. temp. [°C]	Max. continuous operating temp. [°C]	Dimensions: Chamber L x W x D [mm]	Dimensions: External H x W x D [mm]	Thermocouple type	Max. power [W]
Single Sole Heated Oven	1000	950	610 x 280 x 280	2200 x 2000 x 1200	N	12000

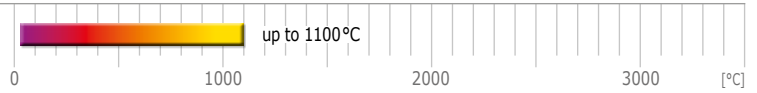

## CRI – Coke Reactivity Furnace

Knowing the physical properties of coke is important as they predict the behaviour of coke in a blast furnace. The two tests frequently run to predict this are Coke Reactivity Index (CRI) to the Standard listed below and Coke Strength after Reaction (CSR) – see page 20

Standard	Description
<b>ASTM D5341/D5341M-17</b>	Method for Measuring Coke Reactivity Index (CRI)
<b>BS ISO 18894:2018</b>	Coke -- Determination of Coke Reactivity Index (CRI)

The Carbolite Gero Coke Reactivity Index furnace (CRI) determines lump-coke reactivity in carbon dioxide gas at elevated temperatures. When coke lumps descend in the blast furnace they are subjected to reaction with counter current CO<sub>2</sub> and to abrasion as they rub together and against the walls of the furnace. These concurrent processes physically weaken and chemically react with the coke lumps producing an excess of fines that can decrease burden permeability and result in increased coke rates and lost hot metal production. The test method is designed to indirectly measure the behaviour of coke in the blast furnace.



Coke Reactivity Furnace



### Standard features

- Maximum operating temperature 1100 °C
- Eurotherm 2704 controller configured to meet either ASTM D 5341-17 or ISO 18894 (2018)
- Over-temperature protection
- Three heated zones with overall heated length of 700 mm
- Resistance wire heating elements
- Dual wall corrosion and oxidation resistant Inconel sample retort which allows incoming gas to be preheated
- Gas safety system
- Audible safety alarms for over-temperature, low gas flow and flame failure on the gas safety system

A dry coke sample of designated size and origin is reacted with CO<sub>2</sub> gas in a retort at a specified elevated temperature for a specified length of time. The weight retained after reduction determines the CRI. The Carbolite Gero Coke Reactivity Index furnace (CRI) has a maximum operating temperature of 1100 °C with three heating zones with an overall heated length of 700 mm. The modular heating system incorporates low thermal mass insulation and resistance coiled wire elements

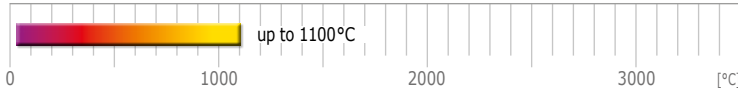

## Control System



Eurotherm 2704 controller. The instrument software is configured for either the ASTM D5341/D5341M-17 or ISO 18894:2018 tests. The instrumentation and associated power control equipment is housed within the integral control cabinet.

## Process Gas

Pipe fittings are provided to connect nitrogen and carbon dioxide which are required at pressures between 1.0 and 2.0 bar. Propane or natural gas is required for a pilot safety burner. The gases are mixed in the gas control cabinet and are fed into the retort by a single gas inlet.

## Gas Safety System



The furnace has an ionisation type flame detector which senses a flame failure and sounds an alarm. Should the flame not automatically re-establish itself within 30 seconds, process gas flow is shut down and a nitrogen purge is activated.

## Cascade control

Cascade control is used to correct the offset between the heating elements and load and uses an additional load loop with a type 'N' thermocouple. The load loop communicates with the element loop, calling for heat according to the load temperature and current program or set-point. The element loop regulates the heat according to element temperature and the requests from the load loop.

## Data Logging

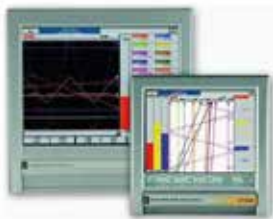

A Eurotherm graphic display data logger is supplied to record process parameters. The channels are factory configured to record the three zone furnace temperatures and sample temperature.

## Alarm Conditions

Audible alarms are provided for over-temperature, low gas flow and flame failure on the gas burn-off. Potentially dangerous alarm conditions abort the process and ensures the insert is safe.

## Over-temperature Protection



An independent thermocouple and temperature controller monitor the furnace temperature. Should an over-temperature condition occur power to the heating elements is switched off.

## Process Control

The test profile is controlled by the main temperature controller. Both temperature and gas flow are operated by the controller.

## Sample Retort

A dual wall reaction retort is constructed from corrosion and oxidation resistant Inconel allowing incoming gas to be pre-heated with provision made for the required probe thermocouple within the retort.

## Technical data

CGH Model	Max. temp. [°C]	Heated zones	Heated length [mm]	Dimensions: External H x W x D [mm]	Control system	Thermocouple type	Max. power [W]
CRI ASTM or ISO	1100	3	700	1800 x 1625 x 1100	Eurotherm 2704	N	10000



## CSR – Coke Strength after Reduction – I-Tester/Tumbler

**The Coke Strength after Reduction (CSR) test measures the resistance of coke to degrade from impact and abrasion during its descent into the blast furnace. The coke is tumbled in a drum 600 times for 30 minutes. Most blast furnace operators require a coke with a CSR greater than 60.**

A single tumbler unit is supplied to enable tumble testing in accordance with ASTM D5341-17 or ISO 18894 (2018). The tumbler is a free standing unit and consists of one drum. To allow worldwide use a variable frequency motor control is fitted, ensuring the tumbler stops after the required number of revolutions defined by the Standard.

The mesh guard has a safety interlock which stops the rotation when opened.

Standard	Description
<b>ASTM D5341/D5341M-17</b>	Method for Measuring Coke Strength after Reaction (CSR)
<b>ISO 18894:2018</b>	Coke -- Determination of Coke Strength after Reaction (CSR)



CSR I-Tester/Tumbler



### Standard features

- Electric motor and gear box
- Variable frequency motor and gear box
- Pre-set counter to ensure exact number of revolutions required
- Safety cage
- Door safety switch
- Emergency stop button



CSI-CSR

## Technical data

<b>CGH</b> Model	Rotation speed [rpm]	Dimensions: Internal Ø x W [mm]	Dimensions: External H x W x D [mm]
<b>CSR</b>	20	129 x 712	1235 x 1040 x 460

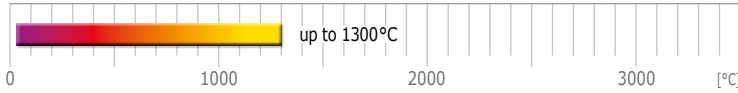

## CTO 7 – Fixed Wall Coke Test Oven

**Carbolite Gero's pilot-scale fixed wall coking oven is designed for the testing of granulated and graded coals for coking under accurately controlled conditions.**

In the production of coke for the metallurgical industries it is important to know how mixes of coal will behave in a commercial coking oven. This evaluation can be carried out quickly and economically in the laboratory by using the Carbolite Gero standard 7 kg capacity coking oven. The charge is based on coal crushed to 85% < 3 mm.

The Carbolite Gero coking oven has been produced to enable qualitative data to be obtained on the conversion of coal to coke using laboratory scale samples.



Fixed Wall Coke Test Oven



### Standard features

- Maximum operating temperature 1300 °C
- 3504P1 standard controller with two 3216 slave controls
- Three vertical element zones heated by silicon carbide elements
- Outer door fitted with thermocouple ports allowing insertion of lance thermocouple probes.
- Over-temperature protection
- Paperless graphic recorder

### Options (specify these at time of order)

- An optional afterburner is available which has a maximum operating temperature of 1320°C with a chamber capacity of 18 litres.
- CTO 23 (50 lbs) available on request
- CTO 115 (253 lbs) available on request
- CTO 227 (500 lbs) available on request
- Loading assembly
- Collection trolley



Collection trolley and loading assembly

## Technical data

CGH	Max. temp. [°C]	Dimensions: Internal H x W x L L = length between doors [mm]	Dimensions: External H x W x D [mm]	Controller	Control & power cabinet Dimensions: External H x W x D [mm]	Charge weight [kg]	Max. power [W]
<b>CTO 7</b>	1300	305 x 115 x 370	1750 x 800 x 700	3504P1	1600 x 800 x 600	7	16000

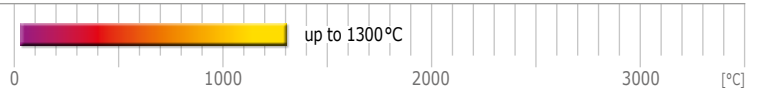

## MWO 227 kg – Variable Width Moving Wall Coking Test Oven

**Designed and built for testing granulated and graded coals for heating under accurately controlled conditions, Carbolite Gero's pilot-scale variable width moving wall coking test oven replicates operating conditions found in commercial coke ovens. The oven continuously measures the maximum coke oven wall pressure and internal gas pressure developed during the carbonisation process.**

An important consideration in selecting a coal blend is that it should not exert a high coke oven wall pressure and that it should contract sufficiently to allow the coke to be pushed out of a commercial oven. The design of the Carbolite Gero oven allows the pressure generated during the coking process to be exerted against a fixed wall on one side and a moving wall on the other. Coking pressure is measured by a load transducer actuated by the moving wall with an operating range of 0-50 kN.



MWO 227 kg with loading platform & hoist, afterburner and control cabinet

### Standard features

- 1300°C maximum operating temperature
- Silicon carbide lined chamber
- Strain gauge load cell 0-50 kN to measure coking pressure
- One combined gas and thermocouple probe to measure charge gas pressure and temperature
- Two separate charge lance probes to measure charge temperature
- Height linear displacement sensor monitors the change in height of the charge during the coking process
- Six vertical element zones
- Double spiral silicon carbide heating elements
- Over-temperature protection
- Door switch on each door to disable power when the door is open
- Free standing control / power cabinet

The oven operates at a maximum temperature of 1300°C and the standard model has a charge weight of 227 kg (500 lbs) (dry basis). The charge is based on coal crushed to 85% < 3 mm containing 10% moisture and oiled at 0.5% by weight with a bulk density of 725 kg/m<sup>3</sup>.

The oven's robust design has a welded rolled hollow section steel frame supporting the main oven and the coking chamber is lined with hollow silicon carbide bricks. Three vertical element zones are located behind each wall. The outer walls are constructed of high density refractory bricks backed by calcium silicate insulating slab.

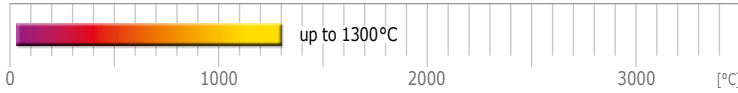

## Additional Widths

The standard furnace's variable width is 455 mm with a nominal charge weight of 227 kg (dry basis). The oven offers optional additional widths (see table below). This can be done by removing the hearth and doors and installing appropriately sized doors.

Width [mm]	Volume [m <sup>3</sup> ]	Charge weight [kg]
<b>Standard width</b>		
455	0.35	227
<b>Special widths (available on request)</b>		
205	0.16	115
305	0.23	170
405	0.31	225
455	0.46	350
560	0.43	310

## Control System

The controls and power equipment are housed within a separate floor standing cabinet which is connected to the oven with 6m of flexible conduit.

## Main Temperature Controllers & Recorders

A choice of two control systems is available:

**Option 1:** A touchscreen Eurotherm Eycon 20 control system combining multi-function control, recording and visualisation in a single unit supported by a Eurotherm 2750 PLC providing access to a wide range of advanced functions.

**Option 2:** A Siemens TP1500 Comfort which combines multi-function control, recording and visualisation in a single unit 15" colour touchscreen display with Ethernet connection and supported by Siemens S7-1200 PLC for intelligent data acquisition and precision control.



Display showing plant overview with zone temperatures, program, lance thermocouples, height indicator and wall pressure.



Display showing control zone temperature and setpoint, % power, lance thermocouples, height indicator and wall pressure.



Display showing settings for 3 programs

## Discharge process



Coke after 18 hours of processing



Discharge of load



Wet quenching



Completion of sample of coke after one hour from initial discharge

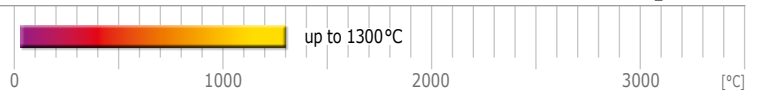

## MWO 227 kg – Variable Width Moving Wall Coking Test Oven

### Options

- **Adjustable load cell calibration unit**  
Adjustable range 0 – 50 kN
- **Additional combined gas and thermocouple probes**  
(if required)
- **Electric afterburner**  
Designed to destroy all toxic gases passing through it, the afterburner connects to the top of the oven and, using a chimney effect, pulls the exhaust gas through the heating chamber. The air inlet can be adjusted by the operator during the process cycle so it opens at the start and gradually closes towards the end of the cycle. The performance of this 3 metre chimney is dependent upon the customer's exhaust chimney. The chamber is designed to provide at least 1.2 seconds residence time at a temperature greater than 1000 °C.
- **Discharge cart dry quench**  
The dry quench is manually placed next to the outlet of the oven. Nitrogen, water and air are needed for its operation. The lid is raised and lowered by an air cylinder and the outer case is cooled by water. The coke sample is cooled by the nitrogen.
- **Discharge cart wet quench**  
Large highly manoeuvrable quench cart with operator protection guard and water outlet holes.
- **Charge hopper & trolley**  
Charge hopper with load operating handle.
- **Discharge ram**  
Manually operated hydraulic discharge ram.
- **Loading platform & hoist**  
Free standing platform with staircase for top loading operation. Integral hoist enables easy lifting and placement of charge hopper over charge hole.
- **Wet quench**  
Evenly spaced water jets on a wall fixing frame



Electric afterburner



Discharge cart dry quench



Discharge cart wet quench



Charge hopper &amp; trolley



Discharge ram



Loading platform &amp; hoist

## Technical data

CGH Model	Max. temp. [°C]	Dimensions: Chamber L x H x H x W [mm]	Dimensions: External H x W x D [mm]	No of elements	Charge weight [kg]	Max. power [W]
<b>Moving Wall Coking Test Oven</b>	1300	915 x 840 x 1015 x 455	6000 x 5000 x 5000	72	227	65000
<b>Oven/afterburner/loading platform</b>	-	-	7400 x 5081 x 5611	27	-	-
<b>Afterburner with 3 metre chimney</b>	1320	-	-	-	-	60
<b>Discharge cart dry quench</b>	-	-	2200 x 1200 x 2800	-	-	-
<b>Discharge cart wet quench</b>	-	-	800 x 1600 x 2700	-	-	-
<b>Charge hopper &amp; trolley</b>	-	-	1600 x 850	-	-	-
<b>Discharge ram</b>	-	-	1700 x 1600 x 3500	-	-	-
<b>Loading platform &amp; hoist</b>	-	-	7400 x 5081 x 5611	-	-	-
<b>Wet quench</b>	-	-	1500 (L)	-	-	-



## GK – Gray King Coke Test Furnace

**Coal analysis techniques are specific analytical methods designed to measure the particular physical and chemical properties of coals.**

The Gray King test furnace assesses the caking properties of a type of coal or a blend of coal by carbonising under standard conditions. Comparing the test data with industrial practice is easily achieved and the behaviour of any coal on carbonisation on a large scale can be reliably predicated.

The Carbolite Gero Gray King test furnace is designed and complies with Standard BS ISO 502:2015 'Coal -- Determination of caking power -- Gray-King coke test'.



Figure 1

The sample is heated in accordance with the Standard to a final temperature of 600 °C. The coke residue obtained is classified by reference to a series of standard residues (see figure 1).

Carbolite Gero offers the choice of two Gray King furnaces. Both furnaces have two zones with the Gray King 1 holding a single silica tube whilst the Gray King 4 can hold up to 4 silica tubes. (Silica tubes should be ordered separately). Both models have one slab resistance element positioned above and one below the aluminium bronze stabilisation block.



### Standard features

- Maximum operating temperature 600 °C
- 3216CC controller and slave control
- Aluminium bronze stabilisation block which gives improved uniformity of temperature
- Vacuum formed hot face insulation backed by low thermal mass blanket insulation ensuring maximum thermal efficiency.



GK 4

Two thermocouples are located within the stabilisation block – thermocouples are housed in protective ceramic sheaths.

The furnace incorporates a wheel and rail system that allows the furnace to be retracted from the quartz tubes to allow cooling, as required by the Standard.

### Options (specify these at time of order)

- Silica tube

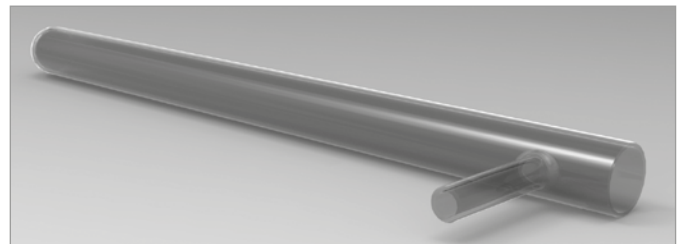

## Technical data

CGH Model	Max. temp. [°C]	Dimensions: Internal Ø x L [mm]	Dimensions: External H x W x D [mm]	No. of quartz tubes	Controller type	Max. power [W]
GK 1	600	50 x 300	420 x 730 x 250	1	3216CC	1000
GK 4	600	50 x 300	420 x 730 x 400	up to 4	3216CC	1900

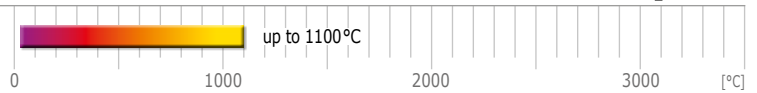

## IOR – Iron Ore Reducibility Furnace

The Carbolite Gero IOR furnace meets the Standards listed below. It provides a relative measure with which oxygen, combined with iron, can be removed from natural or processed iron ores by a reducing gas, when reduced under conditions resembling those prevailing in the reduction zone of the blast furnace.

The test consists of isothermal reduction of a test portion at a specified size range. The test piece is located in a fixed bed within a reducing atmosphere, at a temperature dependent on the standard being used.

The furnace can be used for testing to either one, or combining up to three, of the following International Standards:

Standard	Description
<b>BS ISO 4695:2015</b>	Iron ores for blast furnace feedstocks - Determination of the reducibility by the rate of reduction index. This standard specifies a method to provide a relative measure for evaluating the extent to and ease with which oxygen can be removed from iron ores, when reduced under conditions resembling those prevailing in the reduction zone of a blast furnace. This standard is applicable to lump ores, sinters and hot-bonded pellets.
<b>BS ISO 4696-1:2015</b>	Iron ores for blast furnace feedstocks - Determination of low-temperature reduction-disintegration indices by static method. Reduction with CO, CO <sub>2</sub> , H <sub>2</sub> and N <sub>2</sub> .
<b>BS ISO 4696-2:2015</b>	Iron ores for blast furnace feedstocks - Determination of low-temperature reduction - disintegration indices by static method - Part 2: Reduction with CO and N <sub>2</sub> . A relative measure for evaluating the degree of size degradation of iron ores when reduced with carbon monoxide and nitrogen, under conditions resembling those prevailing in the low-temperature reduction zone of a blast furnace. This part of ISO 4696 is applicable to lump ores, sinters and hot-bonded pellets.
<b>BS ISO 4698:2007</b>	Iron ore pellets for blast furnace feedstocks - Determination of the free-swelling index. A relative measure for evaluating the increase in the volume of iron ore pellets when reduced in an unconstrained bed under conditions resembling those prevailing in the reduction zone of a blast furnace. It specifies the determination of the free-swelling index. This Standard is applicable to hot-bonded pellets.
<b>BS ISO 7215:2015</b>	Iron ores for blast furnace feedstocks - Determination of the reducibility by the final degree of reduction index. A relative measure for evaluating the extent to which oxygen can be removed from iron ores when reduced under conditions resembling those prevailing in the reduction zone of the blast furnace. This Standard is applicable to lump ore, sinters and hot-bonded pellets.
<b>BS ISO 7992:2015</b>	Iron ores for blast furnace feedstocks - Determination of reduction under load. A relative measure for evaluating the structural stability of iron ores when reduced under conditions resembling those prevailing in the reduction zone of a blast furnace.



Iron Ore Reducibility Furnace with 3-zone vertical chamber and side integral control box

With a maximum operating temperature of 1100°C the furnace provides a temperature stability better than  $\pm 1^\circ\text{C}$  under steady state conditions. The three zone vertical chamber has a heated length of 700 mm. The temperature controllers, associated power control equipment and gas control equipment are housed within the integral control box at the side of the furnace.



### Standard features

- Maximum operating temperature 1100°C
- Eurotherm 2704 control system with Eurotherm graphic display data logger
- Overall heated length 700 mm
- Three zone vertical chamber
- Over-temperature protection & gas safety system
- Mettler Toledo balance to determine the loss in mass of the reduced sample
- Corrosion and oxidation resistant Inconel retort is provided for each test specification (up to a maximum of 3)

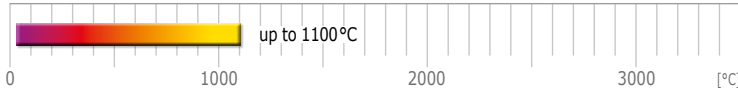

## Control System

Eurotherm 2704 controller. The instrument software is pre-configured for the relevant ISO test. Input and output boards enable the process gases to be switched on and off as required. The instrumentation and associated power control equipment are housed within the integral control cabinet.

## Cascade control

Cascade control is used to correct the offset between the heating elements and load and uses an additional load loop with a type 'N' thermocouple. The load loop communicates with the element loop, calling for heat according to the load temperature and current program or set-point. The element loop regulates the heat according to element temperature and the requests from the load loop.

## Data Logging

A Eurotherm graphic display data logger is supplied to record process parameters. The channels are factory configured to record the three zone furnace temperatures, sample temperature and also the weight.

## Process Gas

The test profile is controlled by the main temperature controller; both temperature and gas flows are operated by the controller. Due to the function of instrumentation, the equipment is considered to be semi-automatic; the operator is required to load and unload the furnace.

Pipe fittings are provided for the relevant gases. Propane or natural gas is required for a pilot safety burner. The gases are mixed in the gas control cabinet and are fed into the retort by a single gas inlet.

## Gas Safety System

The furnace has an ionisation type flame detector which senses a flame failure and sounds an alarm. Should the flame not automatically re-establish itself within 30 seconds, the process gas flow is shut down and a nitrogen purge is activated.

## Alarm Conditions

Audible alarms are provided for over-temperature, low gas flow and flame failure on the gas burn-off. Potentially dangerous alarm conditions abort the process and ensures the equipment is safe.

## Over-temperature Protection

An independent thermocouple and temperature controller monitor the furnace temperature. Should an over-temperature condition occur power to the heating elements is switched off.

## Corrosion and oxidation resistant Inconel Retort

A retort is provided for each test specification. Each retort is manufactured from 2 mm thick corrosion and oxidation resistant Inconel and has a double wall construction. The retorts have gas inlet and outlet connections and the lids are bolted into position. Provision is made for probe thermocouples within the retort.

## Measurement of Weight Loss

A balance is supplied in order to determine the loss in mass of the reduced sample. The balance, with a resolution of 0.1 g, is connected to the retort during the entire process cycle.

## Technical data

<b>CGH</b> Model / Combinations of Standards	Max. temp. [°C]	No. of control zones	Dimensions: External H x W x D [mm]	Temperature control system	Heated length [mm]	Thermo-couple type	Max. power [W]
<b>Iron Ore combined test unit</b>	1100	3	1800 x 1625 x 1100	Eurotherm 2704	700	N	10000
<b>ISO 4695 &amp; BS ISO 4696-1:2015</b>	1100	3	1800 x 1625 x 1100	Eurotherm 2704	700	N	10000
<b>ISO 4695 &amp; BS ISO 4696-2:2015</b>	1100	3	1800 x 1625 x 1100	Eurotherm 2704	700	N	10000
<b>BS ISO 4696-2:2015 &amp; BS ISO 4698:2007 &amp; BS ISO 7992:2015</b>	1100	3	1800 x 1625 x 1100	Eurotherm 2704	700	N	10000
<b>BS ISO 7215:2015</b>	1100	3	1800 x 1625 x 1100	Eurotherm 2704	700	N	10000
<b>BS ISO 4696-2:2015 &amp; BS ISO 7215:2015 &amp; BS ISO 7992:2015</b>	1100	3	1800 x 1625 x 1100	Eurotherm 2704	700	N	10000



## IOT – Iron Ore Tumbler

**The Carbolite Gero iron ore tumbler meets Standard BS ISO 4696-1:2015 'Iron ores for blast furnace feedstocks -- Determination of low-temperature reduction-disintegration indices by static method -- Part 1. It is applicable to lump ores, sinters and hot-bonded pellets.**

This test method provides a relative measure for evaluating the degree of size degradation of iron ores when reduced with carbon monoxide, carbon dioxide, hydrogen and nitrogen under conditions resembling those prevailing in the low-temperature reduction zone of a blast furnace.

The reduced test portion is tumbled in a single tumble drum for 30 revolutions per minute. This easy to operate free standing tumbler is manufactured from 1.6 mm mild steel plate connected to a single shaft which is rotated by an electric motor. To allow worldwide use a variable frequency motor control is fitted, ensuring the tumbler stops after the required number of revolutions defined by the Standard.

The mesh guard has a safety interlock which stops the rotation when opened.



Iron Ore tumbler



### Standard features

- Electric motor and gear box
- Variable frequency motor and gear box
- Pre-set counter to ensure exact number of revolutions required
- Safety cage
- Door safety switch
- Emergency stop button

## Technical data

CGH Model	Rotation speed [rpm]	Dimensions: Internal Ø x W [mm]	Dimensions: External H x W x D [mm]
Iron ore tumbler	30	130 x 200	935 x 360 x 525

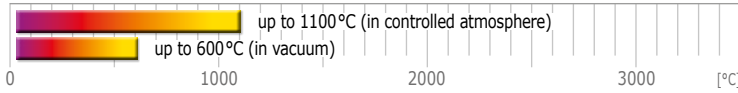

## GLO 40/11-1G – Coal characterisation

The characterisation of coal requires various tests, including heating it in a nitrogen atmosphere up to 1000°C where pyrolysis occurs. During this process, the coal loses a degree of weight which is a good measure of its quality. The Carbolite Gero GLO 40/11-1G is used for this process to analyse how the coal reacts and to determine its behaviour.

For this specific process the furnace is modified for pyrolysis and the gas outlet is not equipped with any valves, therefore there is no pump. Inertisation is achieved by purging with nitrogen or argon prior to heating and to ensure maximum safety this is done in a vessel. The gas outlet is equipped with a heated gas outlet and an afterburner.

The sample is placed on a horizontal charging rack and the incoming gases are guided uniformly over the sample by a gas circulation system. Any gaseous by-products are immediately flushed out of the furnace.

The GLO 40/11-1G offers excellent temperature uniformity. A probe thermocouple is positioned at the rear of the furnace in close proximity to the sample, which serves as the control thermocouple for the two heating zones monitoring the temperature at the sample.



GLO 40/11

### Standard features

- 1100°C maximum operating temperature
- Excellent temperature uniformity
- 40 litre capacity
- Precisely controlled atmosphere with optimum purity
- Temperature resistant steel alloy retort
- Afterburner
- Certified safety system for flammable and toxic gases
- Choice of fully automatic or manual operation
- Data recording for quality management
- Compact, space saving design

### Options (specify these at time of order)

- Choice of software and controller options
- Fast heat up and cool down options
- Thermocouple probes in retort
- Chiller, should no water cooling be available on-site

## Technical data

CGN Model	Max. operating temperature [°C]	Dimensions: External H x W x D [mm]	Volume [l]	Max. Power [W]
GLO 40/11-1G	1100	1900 x 1400 x 1800	40	25000



## LTD – Low Temperature Reduction – Disintegration of Iron Ore

**The Carbolite Gero furnace for dynamic testing for low temperature reduction – disintegration of Iron Ore meets the International Standard BS ISO 13930:2015 'Iron ores for blast furnace feedstocks -- Determination of low-temperature reduction-disintegration indices by dynamic method' specifications. This Standard test method can be used to provide results as part of a production quality control system, as a basis of a contract, or as part of a research project.**

The test provides a relative measure for evaluating the degree of size degradation of iron ores when reduced under conditions resembling those prevailing in the low-temperature reduction zone of the blast furnace.

Iron ore pellets, which have been thoroughly dried, are placed in a rotating tube and subject to "tumbling during reduction". The test portion is isothermally reduced in a rotating tube at 500°C using a reducing gas consisting of CO, CO<sub>2</sub>, H<sub>2</sub> and N<sub>2</sub> for 60 minutes.

The corrosion and oxidation resistant Inconel retort is a rotating reduction barrel containing 4 lifter bars which rotates about its axis within the furnace. Agitation of the sample ensures all surfaces are subjected to the reducing atmosphere. Provision is made for the required probe thermocouple within the retort. The samples are then subjected to a sieve analysis to determine the degree of disintegration.



Low Temperature Reduction - Disintegration of Iron Ore Furnace

The reduction barrel is driven from a variable speed electric motor. The front section of the furnace is mounted on a counter balanced parallel link mechanism which allows easy access for loading and unloading the reduction barrel. A dust collector is placed at the end of the gas outlet to collect dust exiting the rotating tube.



### Standard features

- Maximum operating temperature 1000°C (without reduction barrel)
- Eurotherm 2704 controller with cascade control and graphic display data logger
- Easy access for loading and unloading the reduction barrel
- Gas safety system
- Audible alarm system for over-temperature, low gas flow and flame failure on the gas burn off
- Corrosion and oxidation resistant Inconel retort

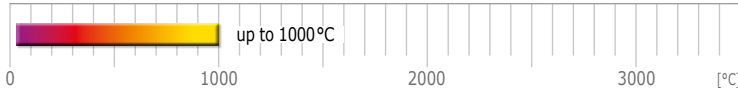

## Control System



A Eurotherm 2704 controller. The instrument software is pre-configured for the relevant ISO test. Input and output boards enable the process gases to be switched on and off as required. The instrumentation and associated power control

equipment are housed within the integral control cabinet.

## Cascade control

Cascade control is used to correct the offset between the heating elements and load and uses an additional load loop with a type 'N' thermocouple. The load loop communicates with the element loop, calling for heat according to the load temperature and current program or set-point. The element loop regulates the heat according to element temperature and the requests from the load loop.

## Data Logging



A Eurotherm graphic display data logger is supplied to record process parameters. The channels are factory configured to record the three zone furnace temperatures, sample temperature and also the weight.

## Process Gas

Nitrogen, carbon monoxide, carbon dioxide and hydrogen are required and pipe fittings are provided for customer connection. Propane or natural gas is required for a pilot safety burner. With the exception of the propane line, the gas supplies are divided and pass through a series of needle valves and flowmeters, allowing flow control of process gas. The gases combine providing a single gas inlet into the retort.

## Gas Safety System

The furnace has an ionisation type flame detector which senses a flame failure and sounds an alarm. Should the flame not automatically re-establish itself within 30 seconds, process gas flow is shut down and a nitrogen purge is activated.

## Alarm Conditions

Audible alarms are provided for over-temperature, low gas flow and flame failure on the gas burn-off. Potentially dangerous alarm conditions abort the process and ensures the equipment is safe.

## Over-temperature Protection



An independent thermocouple and temperature controller monitor the furnace temperature. Should an over-temperature condition occur power to the heating elements will be switched off.

## Technical data

CGH Model	Max. temp. [°C]	Heating zones	Heated length [mm]	Dimensions: External H x W x D [mm]	Inconel retort Ø x length [mm]	Thermocouple type	Control system	Max. power [W]
<b>Dynamic testing for low temperature reduction</b>	1000 / 800 (without / with reduction barrel)	3	715	1500 x 1800 x 1060	150 x 540	N	Eurotherm 2704 Cascade	12000



## CRF/1 – CO<sub>2</sub> Reactivity Test Furnace

The Carbolite Gero CRF/1 CO<sub>2</sub> reactivity test furnace complies with the Standard test method for the determination, by a loss in mass method, of the reactivity to carbon dioxide of calcined petroleum coke used in the manufacture of anodes for the production of aluminium.

The furnace conforms to the following Standards:

Standard	Description
<b>ISO 12981-1</b>	Carbonaceous materials used in the production of aluminium -- Calcined coke -- Determination of the reactivity to carbon dioxide -- Part 1: Loss in mass method
<b>BS 6043-2.20.1</b>	Determination of the reactivity by a loss in mass method

The reactivity of a calcined coke to carbon dioxide is assessed by determining the loss in mass of a sample exposed in accordance with the following chemical reaction:  $C + CO_2 \rightarrow 2 CO$ . This determination allows an assessment of the later anode reactivity to carbon dioxide in the electrolysis cell.

Once the CRF/1 reaches the maximum operating temperature of 1000 °C an audible alarm is sounded to indicate when the sample can be loaded. The coke sample of 5 g, having a grain size of 1 mm to 1.4 mm, can then be placed into the quartz tube. An automatic mass flow meter then opens the CO<sub>2</sub> gas flow for approximately 100 minutes



CRF/1

NEW



exposing the sample to a carbon dioxide stream of 50 l/h. The loss in mass is then measured.

The CRF/1 is a single zone tube furnace with good vertical temperature distribution which heats up to 1000 °C. The temperature is maintained with an accuracy of  $\pm 1$  °C. The furnace has a tube reactor with two quartz tubes and a cap with a ground glass joint. An external tube containing a gas inlet allows the gas to flow down to the bottom of the tube and be preheated before flowing up through the coke bed. Fitted inside the external tube is an inner reaction tube incorporating a porous disc so that the base of the coke bed lies in the middle of the furnace.

### Standard features

- Maximum operating temperature 1000 °C
- Over-temperature protection
- Eurotherm 3508 controller
- Single zone furnace with a heated length of 220 mm
- Two quartz tubes
- High grade insulation
- Mass flow meter
- Internal cooling chamber

### CRF cross section

- 1) Gas tube
- 2) Quartz tube
- 3) Sample holder
- 4) Thermocouple
- 5) Mass flow controller
- 6) Gas pressure regulator
- 7) Gas inlet
- 8) Controller

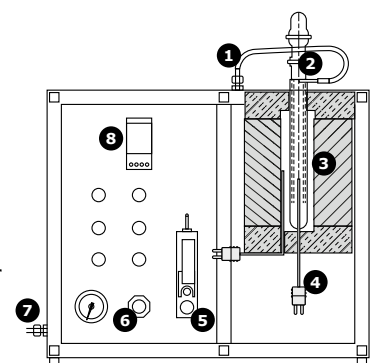

## Technical data

CGH Model	Max. temp. [°C]	Dimensions: External H x W x D [mm]	Temperature control system	Heated zones	Heated length [mm]	Thermocouple type	Max. power [W]
CRF/1	1000	520 x 600 x 400	Eurotherm 3508	1	220	K	1000



## Coal and Coke Products – Standards Summary

Page	Model																
	MFS/1	CDLT	CDHT	VMF	AAF	SNF	CFM	CAF G5	SHO	CRI	CSR	GK	IOR	IOT	LTD	CRF/1	
	6	7	7	8-9	10-11	12	13	14-16	17	18-19	20	25	26-27	28	30-31	32	
<b>DIN</b>																	
DIN 51730:2007-09								○									
<b>ASTM</b>																	
ASTM D1857 / D1857M - 18								○									
ASTM D2013/D2013M-12		○															
ASTM D2014-97									○								
ASTM D2961-11			○														
ASTM D3173-11	○																
ASTM D3174-12					○												
ASTM D3175-20				○													
ASTM D3302		○															
ASTM D4239							○										
ASTM D5341/D5341M-17										○	○						
ASTM D720-15						○											
<b>BS</b>																	
BS 1016-1:1973		○	○														
BS 1016-106.4.2:1996							○										
BS 1016-106.1.1:1996							○										
BS 6043-2.20.1																○	
<b>BS ISO</b>																	
BS ISO 1171:2010					○												
BS ISO 11722:2013	○																
BS ISO 13909-1:2016		○	○														
BS ISO 13909-2:2016		○	○														
BS ISO 13930:2015																○	
BS ISO 18894:2018										○	○						
BS ISO 4695:2015													○				
BS ISO 4696-1:2015													○	○			
BS ISO 4696-2:2015													○				
BS ISO 4698:2007													○				
BS ISO 501:2012						○											
BS ISO 502:2015												○					
BS ISO 540:2008									○								
BS ISO 562:2010				○													
BS ISO 579:2013		○	○														
BS ISO 687:2010	○																
BS ISO 7215:2015													○				
BS ISO 7992:2015													○				
<b>ISO</b>																	
ISO 12981-1:2000																	○
ISO 609:1996							○										
<b>Other Standards</b>																	
DD CEN/TS 15370-1:2006								○									
PD CEN/TR 15404:2010								○									

## Index

Model	Description	up to	Page
<b>AAF</b>	Coal Ashing Furnaces	1100°C	10-11
<b>CAF G5</b>	Coal Ash Fusibility Furnaces	1600°C	14-16
<b>CDHT</b>	Coal Drying Ovens	200°C	7
<b>CDLT</b>	Coal Drying Ovens	50°C	7
<b>CFM</b>	Combustion Tube Furnace	1400°C	13
<b>CRF/1</b>	CO <sub>2</sub> Reactivity Test Furnace	1000°C	32
<b>CRI</b>	Coke Reactivity Furnace	1100°C	18-19
<b>CSR</b>	Coke Strength after Reduction Tumbler	-	20
<b>CTO</b>	Fixed Wall Coke Test Oven	1300°C	21
<b>GK</b>	Gray King Coke Test Furnace	600°C	25

Model	Description	up to	Page
<b>GLO</b>	Coal Characterisation Pyrolysis Furnace	1100°C	29
<b>IOR</b>	Iron Ore Reducibility Furnace	1100°C	26-27
<b>IOT</b>	Iron Ore Tumbler	-	28
<b>LTD</b>	Low Temperature Reduction – Disintegration of Iron Ore (ISO 13930: 2015)	1000°C	30-31
<b>MFS/1</b>	Minimum Free Space Oven	210°C	6
<b>MWO</b>	Variable Width Moving Wall Coking Test Oven	1300°C	22-24
<b>SHO</b>	Single Sole Heated Oven	1000°C	17
<b>SNF</b>	Swelling Number Index Furnace	900°C	12
<b>VMF</b>	Volatile Matter Furnace	1000°C	8-9

## Optional Part Specifications and Item Numbers

Part Number	Product	Description	Height [mm]	Width [mm]	Depth [mm]	Crucible			Lid	
						External Ø [mm]	Height [mm]	Wall thickness [mm]	External Ø [mm]	External height [mm]
<b>40-209-460-0025</b>	VMF 10/6	Crucible & lid	-	-	-	24.5-25.5	37.5-38.5	1	27-28	7-8
<b>00037-3-2003</b>	VMF 10/6	4 crucible stand (not including handle)	51	102	81	-	-	-	-	-
<b>00037-3-2004</b>	VMF 10/6	9 crucible stand (not including handle)	51	142	121	-	-	-	-	-
<b>00125-3-1007</b>	VMF 10/6	Crucible stand / tray loading handle	25	46	345	-	-	-	-	-
<b>40-209-010-0020</b>	VMF/ASTM	Inconel crucible & lid	-	-	-	27	34	0.7	26.5	11
<b>00329-3-2001</b>	VMF/ASTM	Wire crucible holder	118	120	78	-	-	-	-	-
<b>40-209-460-0050</b>	AAF MFS/1	Fused silica crucible	-	-	-	55	15	2.5	-	-
<b>40-209-100-0010</b>	AAF, MFS/1	Aluminium crucible lid (as requested in ASTM D3174-12)	-	-	-	-	-	-	54	3-4
<b>00057-3-2006</b>	SNF	Additional crucible holder	89	130	88	-	-	-	-	-
<b>40-209-460-0035</b>	SNF	Crucible lid with 06mm hole	-	-	-	-	-	-	46-48	14
<b>SNF-CRUCIBLE-K</b>	SNF	Additional crucible kit (crucible & lid – without hole)	-	-	-	40-42	25-27	2	46-48	14
<b>TU-IAP-025-0750</b>	CFM	IAP work tubes	-	-	-	25 (iØ)	32 (oØ)	750 (length)	-	-
<b>00047-4-1532-SP</b>	MFS/1	Additional tray for desiccator	21	190	235	-	-	-	-	-
<b>00167-3-2051</b>	AAF 11/3	Additional tray	16	136	223	-	-	-	-	-
<b>00167-3-2054</b>	AAF 11/7	Additional tray	16	166	343	-	-	-	-	-

### Custom Designed Ovens & Furnaces up to 3000°C

Carbolite Gero can provide custom solutions for all products up to 3000°C by modification of a standard product or custom designing a product to provide a customer specific process solution.

### Vacuum, Inert & Reactive Gas Furnaces up to 3000°C

With the formation of Carbolite Gero, customers requiring heat treatment processes from 30°C to 3000°C have access to a single highly qualified source for equipment. Carbolite Gero instruments work with vacuum, partial pressure, air, controlled pressure and overpressure environments.

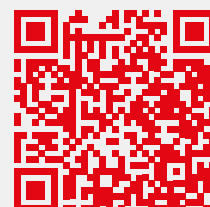

Download the catalogue now!

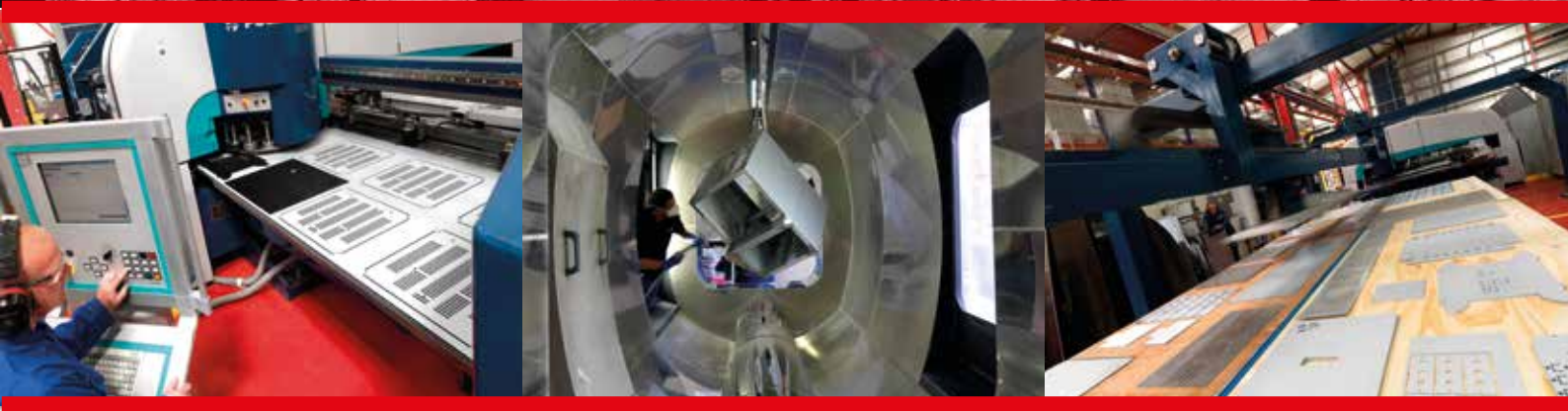

## Sign up for our newsletter!

You will occasionally receive **exclusive information** on seminars/webinars, applications and product news.

Subscribe now:

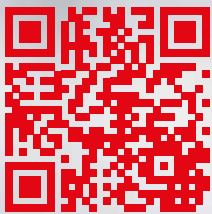

[www.carbolite-gero.com/newsletter](http://www.carbolite-gero.com/newsletter)  
(You may unsubscribe any time)

