

Installation and Operation Instructions

1100°C Oscillatory Reactor Furnace - TSO 1000mm

TSO 11/1000

Contents

This manual is for guidance on the use of the Carbolite Gero product specified on the front cover. This manual should be read thoroughly before unpacking and using the furnace or oven. The model details and serial number are shown on the back of this manual. Use the product for the purpose for which it is intended.

1.0	Introduction	5
1.1	Scope and Purpose	5
1.1.1	Responsibilities	5
1.2	Prerequisites to Use	6
2.0	Safety	7
2.1	Symbols and Warnings	7
2.2	Operator Safety	8
2.3	Risk Prevention and Mitigating Residual Risks	9
2.4	Safety Warning - Refractory Fibre Insulation	10
3.0	Product Overview	11
3.1	Product Rating Label	11
3.2	Part Identification	12
3.3	Control Box Input / Output Identification	13
3.4	TSO Input/Output Identification	14
3.5	Product Labels	15
3.6	Dimensions	16
4.0	Specifications	18
4.1	Drive System	18
4.2	Vessel	18
5.0	Electrical Specifications	19
5.1	Fuses and Power Settings	19
5.2	Drive Speed Control Box	20
5.2.1	Mains Supply Cable	20
5.2.2	Fuse Ratings	20
5.3	Operating / Storage Environment	21
6.0	Options and Accessories	22
6.1	Inert Gas Package (Standard / Advanced)	22
6.2	Probe Thermocouple (Optional)	22
6.2.1	Cascade Control	22
7.0	Installation	25
7.1	Manual Handling	25

7.1.1	Sling Guides	25
7.2	Unpacking	26
7.3	End Guard Installation	27
7.4	Lid Prop	29
7.5	Pneumatic Strut Replacement	31
7.6	Insulation Collar Replacement	32
7.7	Loading the Vessel	36
7.7.1	Vessel Parts	36
7.8	End Seal Installation	37
7.8.1	Left-Hand Side End Seal	38
7.8.2	Right-hand Side End Seal	40
7.8.3	Probe Thermocouple End Plate	43
7.9	Lubricating Gears	44
7.10	Installing the Vessel	45
7.11	Gas Supply Connections	48
7.12	Electrical Supply Connections	49
7.13	Electrical Connections	50
7.13.1	1-Phase Connections	50
7.13.2	3-Phase Connections	51
7.14	Mains Supply Cable	51
7.15	Connecting a Supply Cable to Internal Terminals	51
8.0	Commissioning	53
8.1	Pre-Commissioning	53
8.2	Commissioning - Initial Function Checks	54
9.0	Temperature Controller	56
10.0	Operation	57
10.1	Operating Cycle	57
10.2	Safe Operation	59
10.3	Speed Control Box	60
10.4	Recommendations for Vessel Usage	61
10.4.1	Running at High Temperatures	61
10.5	Vessel Care (Quartz/Silica)	61
10.6	Devitrification	61
10.7	Insulation Cracking	62
10.8	Pressure	63
11.0	Maintenance	64
11.1	General Maintenance	64

11.2	Maintenance Schedule	64
11.3	Cleaning	66
11.4	Safety Switch	66
11.5	Calibration	67
11.6	After-Sales Service	67
11.7	Recommended Spare Parts and Spare Parts Kit	67
11.8	Maintenance Manual	67
12.0	Fault Analysis	68
A.	Furnace Does Not Heat Up	68
B.	Product Overheats	69
13.0	Decommissioning, Storage and Disposal	70
13.1	Decommissioning	70
13.2	Storage (Long Term)	70
13.3	Disposal	70
14.0	Declaration of Conformity	71
	Declaration of Conformity	71

1.0 Introduction

1.1 Scope and Purpose

This product is intended to be used within a laboratory environment for the processing or testing of powdered or granular materials at high temperatures. It is intended that a vessel is fitted within the furnace and that materials are placed within the vessel for processing. A variable speed drive system rotates the vessel within the heated zone by 314° to create an oscillatory motion.

It must be installed, commissioned, and operated in accordance with the instructions contained within this manual, and only by trained personnel.

For maintenance instructions, please contact Carbolite Gero to request the separate "Maintenance Manual".



Note: If this product is used for any application other than its intended purpose, as stated by Carbolite Gero, the protection provided by this equipment may be impaired.

Note: Failure to comply with the instructions as stated within this manual will constitute misuse and subsequently void any warranty provided by Carbolite Gero.

1.1.1 Responsibilities

The customer is responsible for conducting their own risk assessment and ensuring that any materials to be processed within the product are suitable to be safely heated to the required temperature, and that appropriate safety measures are taken when handling such materials:

- Any material that is combustible or liable to cause explosions or generate combustible gas must not be processed unless the product is supplied with specialist equipment designed to manage such reactions
- The customer must provide an adequate ventilation and fume extraction system to manage any fumes given off by materials during processing

This product should not be modified or used for any purpose other than that for which it is intended.

1.2 Prerequisites to Use

Prior to the commissioning and use of this product, all personnel involved in its installation, operation and maintenance must be deemed competent and have:

- Read and understood the information contained within this manual
- Received the relevant training with regard to safety and operation of the product
- Been provided with the appropriate PPE (Personal Protective Equipment) required for the safe operation of this product

Note: The customer is responsible for ensuring that all of the above conditions are satisfied before the product is commissioned for use.



Note: Unless otherwise specified, the customer is responsible for the installation of this product and the safe connection of any additional equipment and gas or liquid supply lines.











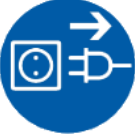











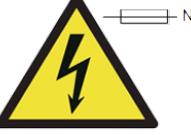

Note: Throughout this manual, written instructions are accompanied by diagrams. Diagrams may be highlighted in different colours and do not reflect the actual colouration of the product. Parts that are to be moved are highlighted in **YELLOW** and are intended to be fixed to, or removed from, surfaces highlighted in **BLUE**. Where applicable, arrows show the direction of movement.

2.0 Safety

2.1 Symbols and Warnings

Note: Observe and take the appropriate precautions if any of the following warning symbols are displayed on this product or in your working environment.

	Refer to the instruction manual before operating or maintaining the equipment		Disconnect the product from the power supply before performing any maintenance
	Wear eye protection		Wear a heat-resistant face shield
	Wear heat-resistant gloves		Wear breathing apparatus
	Wear protective footwear		Wear protective clothing
	Minimum of 2 people required to lift		DANGER: Heavy load. Specialist equipment required!
	WARNING!		DANGER: Risk of electric shock!
	DANGER: Fire risk!		DANGER: Hot surface!
	CAUTION: Double Pole/ Neutral Fusing!		DANGER: Risk of slipping!





	DANGER: Suspended loads!		WARNING: Adequate ventilation required!
	CAUTION: ROTATING EQUIPMENT		DANGER: Risk of crushing injury!
	DANGER: Explosive materials / atmosphere!		Any action noted beside this symbol is strictly forbidden!
	DO NOT use this product to cook or heat food or beverages!		DO NOT dispose! Recycle according to WEEE Regulation guidelines!

2.2 Operator Safety

Note: It is the responsibility of the customer to ensure that all personnel required to operate this product are fully trained and equipped with the appropriate PPE (Personal Protective Equipment).

Carbolite Gero recommend that the appropriate PPE is worn at all times whilst working with and around this product.

2.3 Risk Prevention and Mitigating Residual Risks

Risk		Prevention Measures
	Hot Surface	<ul style="list-style-type: none"> • Wear appropriate PPE e.g. heat resistant gloves • Do not place any objects on top of the product • Ensure the product is sited on a non-flammable surface, and that all adjacent surfaces are also non-flammable
	Ventilation required	<ul style="list-style-type: none"> • Only operate in a well ventilated area • If necessary, only operate in a fume cupboard
	Fire / Explosion	<ul style="list-style-type: none"> • Only trained operators should use this equipment • Only process materials for which a suitable risk assessment has been carried out
	Exposure to hazardous material	<ul style="list-style-type: none"> • Wear appropriate PPE e.g. protective gloves, dust masks, eye protection • Avoid breaking up insulation material • Please refer to section 2.4 for further details • If in doubt, please contact Carbolite Gero Service

2.4 Safety Warning - Refractory Fibre Insulation



Insulation made from High Temperature Insulation Wool Refractory Ceramic Fibre, better known as (Alumina silicate wool - ASW).

This product contains **alumino silicate wool** products in its thermal insulation. These materials may be in the form of blanket or felt, formed board or shapes, slab or loose fill wool.

Typical use does not result in any significant level of airborne dust from these materials, but much higher levels may be encountered during maintenance or repair.

Whilst there is no evidence of any long term health hazards, it is strongly recommended that safety precautions are taken whenever the materials are handled.

Exposure to fibre dust may cause respiratory disease.

When handling the material, always use approved respiratory protection equipment (RPE-eg. FFP3), eye protection, gloves and long sleeved clothing.

Avoid breaking up waste material. Dispose of waste in sealed containers.

After handling, rinse exposed skin with water before washing gently with soap (not detergent). Wash work clothing separately.

Before commencing any major repairs it is recommended to make reference to the European Association representing the High Temperature Insulation Wool industry (www.ecfia.eu).

Further information can be provided on request. Alternatively, Carbolite Gero Service can quote for any repairs to be carried out either on site or at the Carbolite Gero factory.

3.0 Product Overview

3.1 Product Rating Label

The product rating label is located on the side of the product control box.

Note: The image below is an example and does not reflect the product(s) covered by this manual.

UK CA	Carbolite GERO Ltd, Parsons Lane, Hope, Hope Valley, S33 6RB www.Carbolite – Gero.com		CE
	Country of Origin United Kingdom		
Type	TS 12/60/600	Manufactured	2020
	Serial No.	Max Temp	Power
	22-001028	1200°C	2340 W
Frequency	50-60 Hz	Volts	Phases
		240 V	1
		Current	16.0 A

1	UKCA Mark
2	Carbolite Gero address and website
3	CE Mark
4	Country of Origin
5	Product Model
6	Year of Manufacture
7	Dispose of according to WEEE regulations (Waste Electrical and Electronic Equipment Directive)
8	Product Serial Number
9	Maximum Temperature
10	Power Rating
11	Frequency (Hertz)
12	Design Voltage
13	Design Phases
14	Current (Amps)



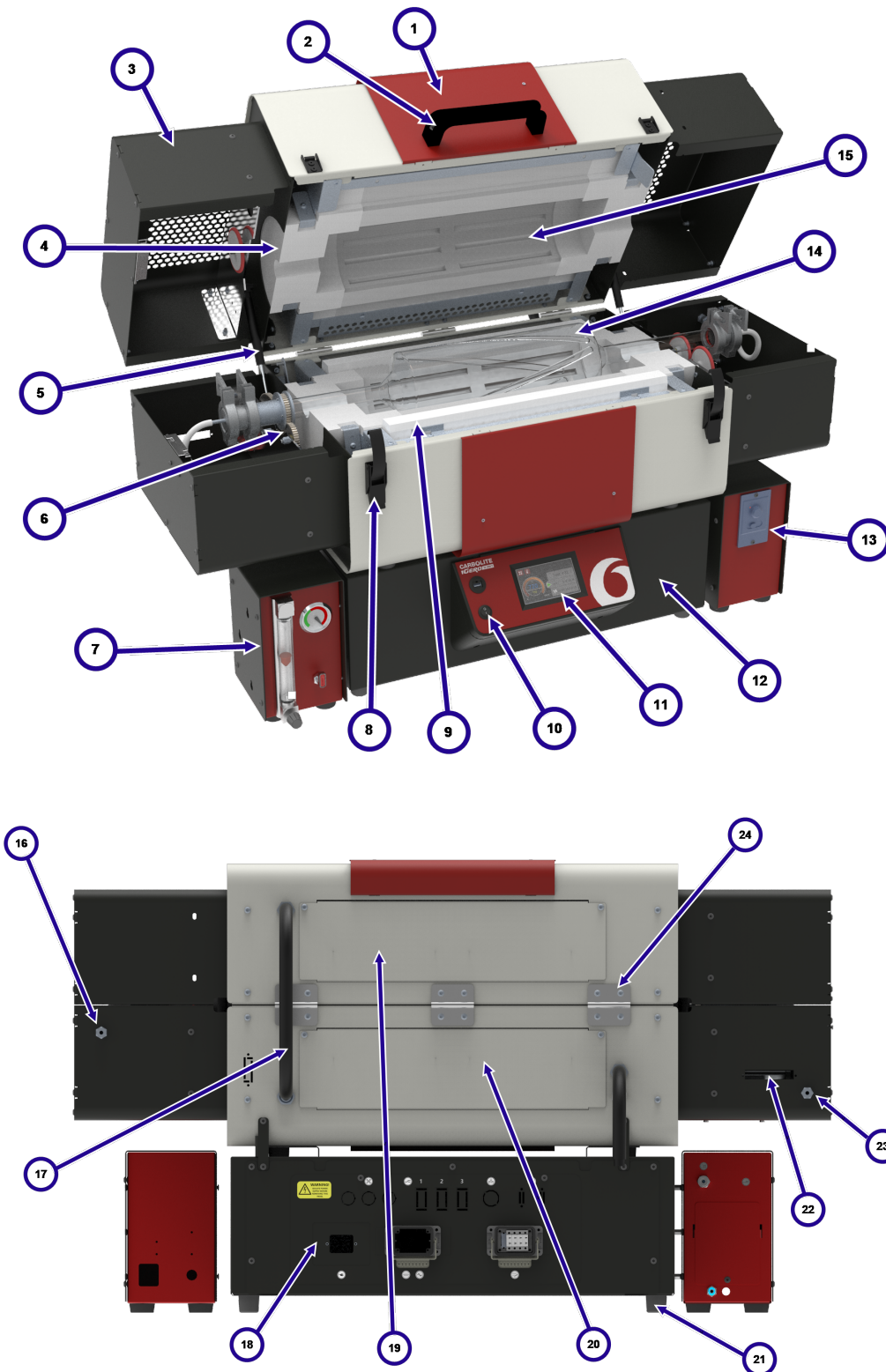



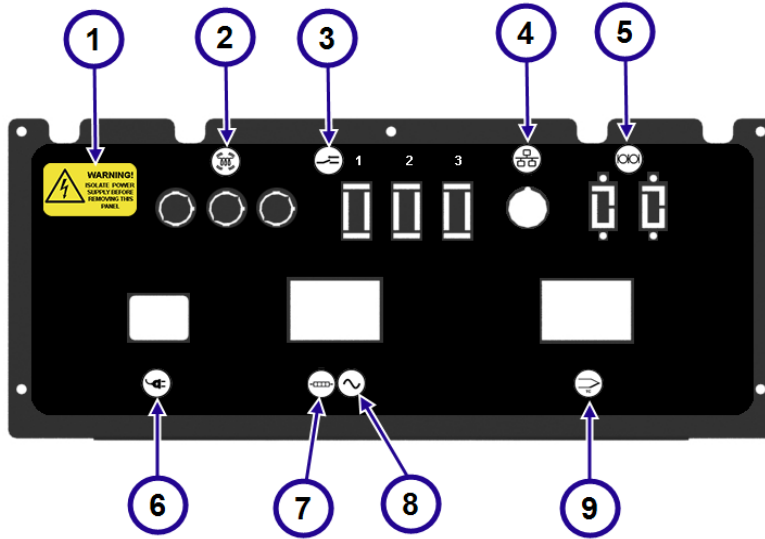

3.2 Part Identification





1	Outer Casing
2	Handle
3	End guard
4	Insulation Collar
5	Pneumatic Strut
6	Drive System
7	Inert Gas Box (optional)
8	Door Latch
9	Insulation Bar
10	Instrument Switch
11	Controller
12	Control Box
13	Drive Speed Control Box
14	Vessel (including end seals and gas connections)
15	Heating Element
16	Gas Outlet
17	Electrical Conduits
18	Electrical Component Access Panel
19	Heating Element Access Panel (1)
20	Heating Element Access Panel (2)
21	Control Box Foot
22	Electrical Connection Inlet
23	Gas Inlet
24	Hinge

3.3 Control Box Input / Output Identification

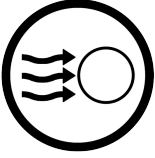
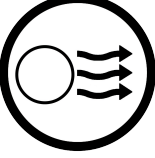

1	 WARNING! ISOLATE POWER SUPPLY BEFORE REMOVING THIS PANEL	Warning! Isolate power supply before removing this panel!
2		Heating Lamps
3		Relay Inputs (optional)
4		Ethernet Communication Port
5		Serial Communications Port(s) (optional)
6		Power Supply Input
7		Power Output to Heating Elements
8		Alternating Current (AC)
9		Thermocouple Input

3.4 TSO Input/Output Identification

	Gas Inlet
	Gas Outlet
	Power Inlet
	Power to Drive Mechanism

3.5 Product Labels

Before commissioning this product, ensure that the following product information and warning labels are in the positions detailed below:

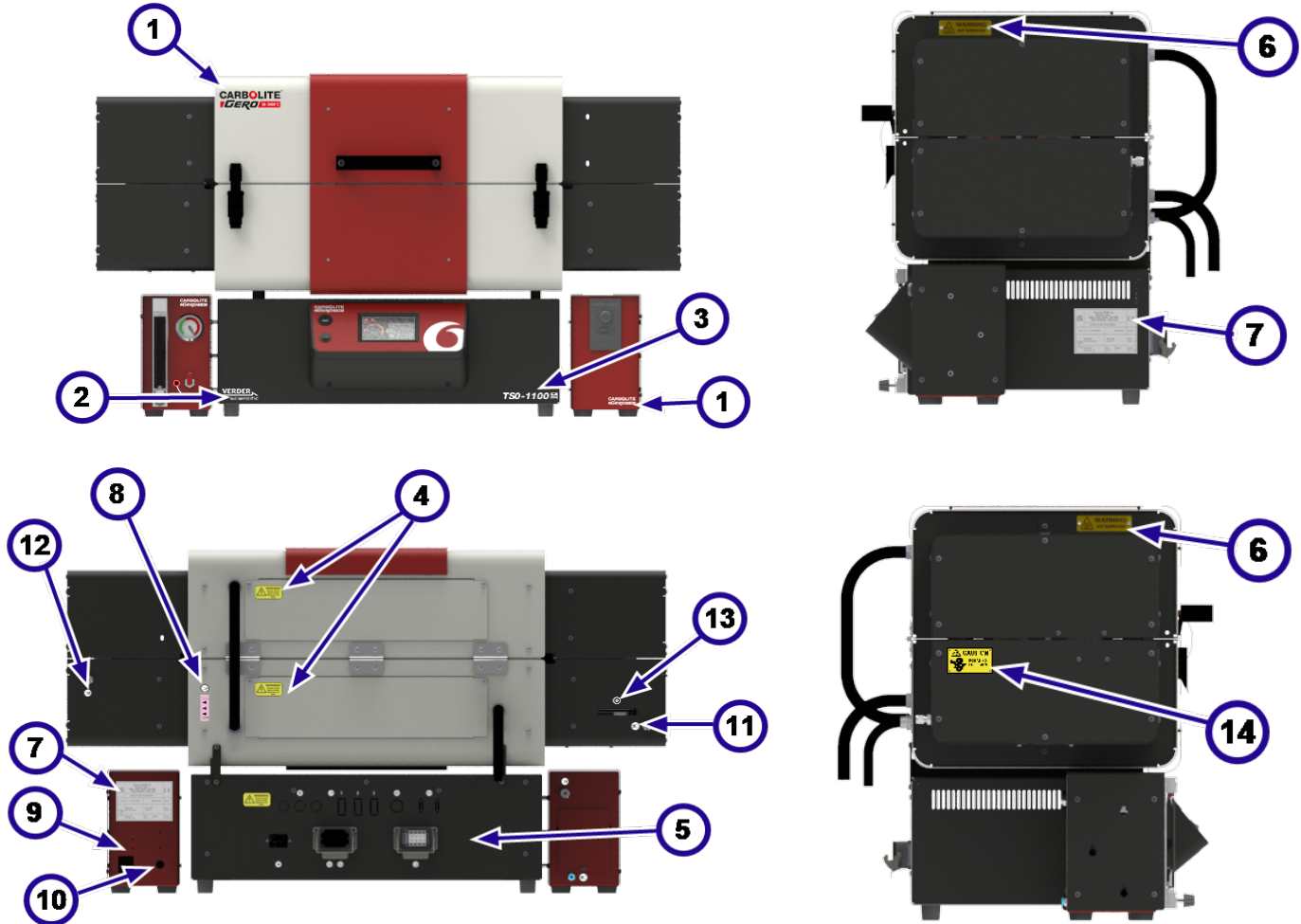

1	Carbolite Gero Logo
2	Verder Scientific logo
3	Product ID Label
4	WARNING: ISOLATE POWER SUPPLY BEFORE REMOVING THIS PANEL
5	Electrical Component Access Panel Label
6	WARNING: HOT SURFACES
7	Product Rating label
8	Probe Thermocouple Socket Label (Cascade Control Option Only)
9	Power Inlet
10	Power Outlet to Drive Mechanism
11	Gas Inlet
12	Gas Outlet
13	Electrical Supply to Drive Mechanism
14	CAUTION: ROTATING EQUIPMENT

3.6 Dimensions

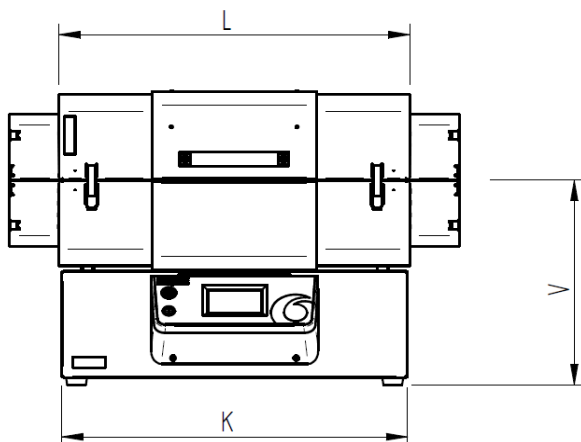
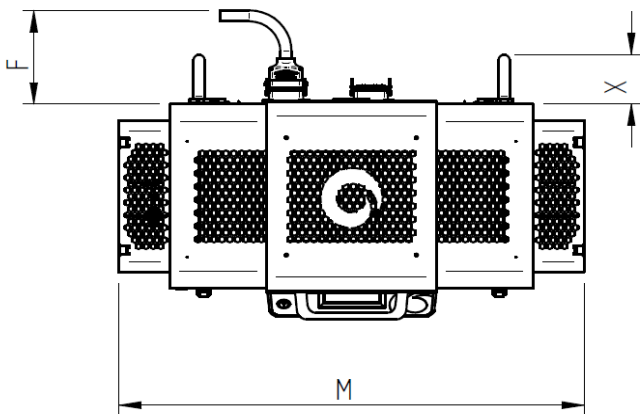
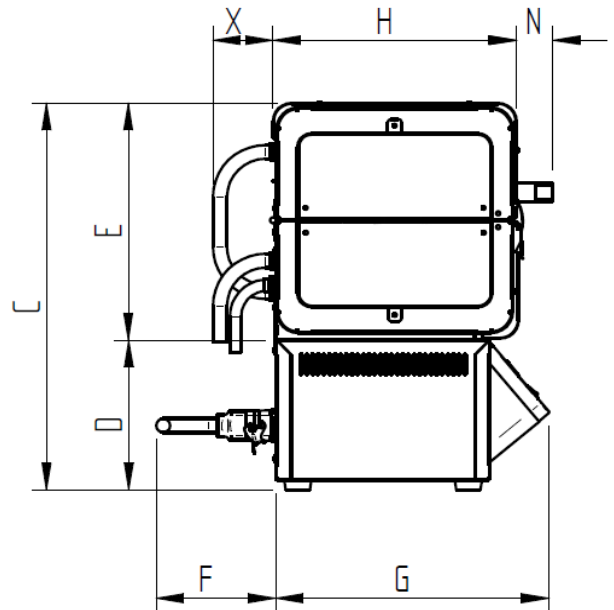
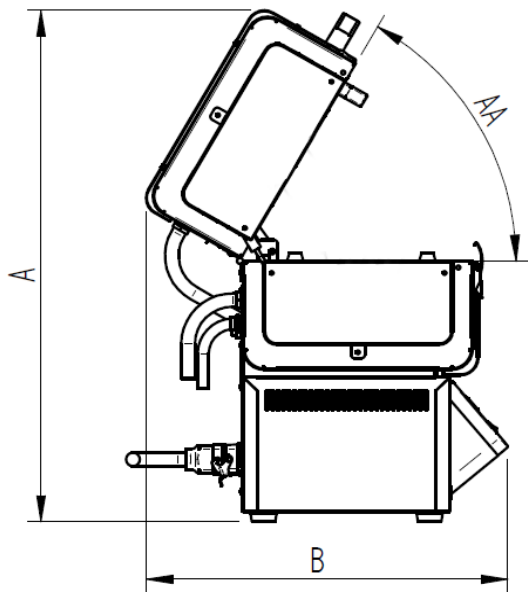

AA	Maximum opening angle
A	Maximum height (open)
B	Maximum depth (open)
C	Height on control box
D	Height of control box
E	Height of furnace case (closed)
F	Minimum depth for control box conduits
G	Depth of control box
H	Depth of furnace case
K	Width of control box
L	Width of furnace case
M	Width with end guards
N	Depth of handle
V	Centre-line height
W	Maximum depth (open, vertical)
X	Minimum depth for furnace conduits

Note: Dimension AA is measured in degrees (°). Dimensions A-Y are measured in millimetres (mm).

AA	A	B	C	D	E	F	G	H	K	L	M	N	V	W	X
60	704	651	N/A	228	445	591	473	431	653	1263	1713	51	233	910	90

Note: The TSO 11/1000 cannot be mounted to the control box. The diagrams above are for example only and do not reflect the product supplied.

4.0 Specifications

Furnace	
Maximum Temperature (°C)	1100
Maximum Continuous Operating Temperature (°C)	1100
Maximum Power (kW)	3.81
Net Weight (kg)	137
Heated Length (mm)	1000

Control Box	
Height x Width x Depth (mm)	228 x 655 x 480
Net Weight (kg)	16

4.1 Drive System

Speed Control Box	
Height x Width x Depth (mm)	240 x 135 x 215
Net Weight (kg)	3

4.2 Vessel

Quartz Vessel	
Net Weight (kg)	1.49
Length of Processing section (mm)	930
Volume Capacity (ml)	1740
Maximum Sample Weight (g)	3500
Fill Fraction (%)	16

5.0 Electrical Specifications



This equipment **MUST** be earthed!

Product Ingress Protection (IP) Rating: 20

5.1 Fuses and Power Settings

Phases	Voltage (V)	Main Fuse (Amps, Type, Size)	Power Turndown (%)
1 phase + Neutral	100*	-	-
	110	-	-
	120	-	-
	200*	20, gG, 10x38mm	100
	208	20, gG, 10x38mm	100
	220	20, gG, 10x38mm	89
	230	20, gG, 10x38mm	82
3 phase + Neutral	240	20, gG, 10x38mm	75
	380	10, gG, 10x38mm	89
	400	10, gG, 10x38mm	82
3 phase (No Neutral)	415	10, gG, 10x38mm	75
	200*	16, gG, 10x38mm	100
	208	16, gG, 10x38mm	100
	240	16, gG, 10x38mm	75

*100V and 200V models may have lower maximum power consumption values, resulting in slightly reduced heat up rates. Please contact Carbolite Gero for further information.

Note:

All auxiliary fuses on standard models are rated at **2 Amps** and should only be replaced with fuses of the following specification: **F2A HBC 5x20mm**.

Auxiliary fuses for models ordered with the Advanced Inert Gas Package are rated at **5 Amps** and should only be replaced with fuses of the following specification: **T5A HBC 5x20mm**.

Note: If the product is fitted with a detachable mains supply cable, DO NOT replace the cable with one that does not meet the rating standards required above.

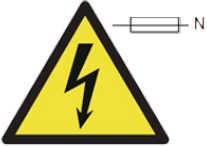

Double Pole Neutral Fusing may be used in this product to protect against faults caused when it is possible to reverse the polarity of the connection to the power supply e.g. in countries that have 2-pin plugs that could be connected "either way".

5.2 Drive Speed Control Box

5.2.1 Mains Supply Cable

IEC	3-core, 1.0mm ² rated to 10 Amp (PVC)
------------	--

5.2.2 Fuse Ratings

Phases	Voltage (V)	Main Fuse (Amps, Type, Size)
1 phase + Neutral	100	T5A HBC 5x20mm
	110	T5A HBC 5x20mm
	120	T5A HBC 5x20mm
	200	F2A HBC 5x20mm
	208	F2A HBC 5x20mm
	220	F2A HBC 5x20mm
	230	F2A HBC 5x20mm
	240	F2A HBC 5x20mm

5.3 Operating / Storage Environment

The products covered by this manual contain electrical parts and should be stored and used in indoor conditions as follows:

Indoor or Outdoor use:	Indoor
Altitude:	Not exceeding 2000 metres
Temperature:	5°C - 40°C
Relative humidity:	Maximum 80% up to 31°C decreasing linearly to 50% at 40°C
Mains Supply Voltage fluctuations:	±10%
Over voltage Category	Category 2
Pollution Degree:	Pollution Degree 2

6.0 Options and Accessories

Note: Any additional equipment to be used with this product should be supplied by Carbolite Gero. Accessories from third-party sources are not designed to Carbolite Gero's specifications and may result in poor performance, damage to equipment or dangerous working conditions.

6.1 Inert Gas Package (Standard / Advanced)

The Carbolite Gero inert gas package flowmeter modules are designed to be used only with inert gases such as argon (Ar), nitrogen (N₂) and helium (He).

The modular system allows for up to three gas lines per furnace, which can be controlled either manually, or automatically via a solenoid valve linked to the furnace temperature controller.

Please refer to the separate Inert Gas Package manual for detailed installation and operation instructions.

6.2 Probe Thermocouple (Optional)

Probe thermocouples enable operators to record more accurate temperature readings inside a heated vessel (work tube, retort, reactor etc.).

A probe thermocouple can be plugged into an independent external temperature reader.

6.2.1 Cascade Control

Furnaces configured to operate via cascade control always require a probe thermocouple.

The operator inputs a setpoint temperature into the controller; this is the temperature that they desire inside the heated vessel, which is measured by the probe thermocouple. The temperature of the heating elements is measured by a separate, built-in thermocouple. The temperature controller reads both thermocouples and calculates the amount of power required to reach the setpoint.

Products ordered with cascade control have a socket at the rear of the furnace body into which the probe thermocouple can be connected.

To connect the probe thermocouple for cascade control:

Note: The thermocouple must be fitted before the vessel is inserted into the furnace.

- Gently twist the compression nut part of the thermocouple gland on the end of the work tube end plate, to loosen the seal and allow for thermocouple access.

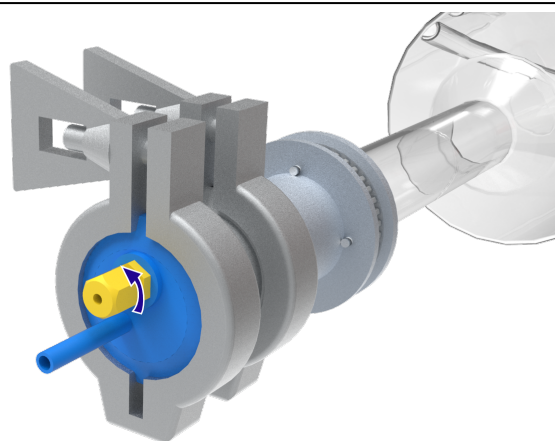

- Carefully insert the probe thermocouple through the gland. Ensure that the thermocouple is pushed fully into the gland.
- Securely tighten the gland to ensure that the thermocouple remains in position and that any atmosphere contained inside the work tube does not escape.
- Insert the vessel into the furnace (see section 7.7).

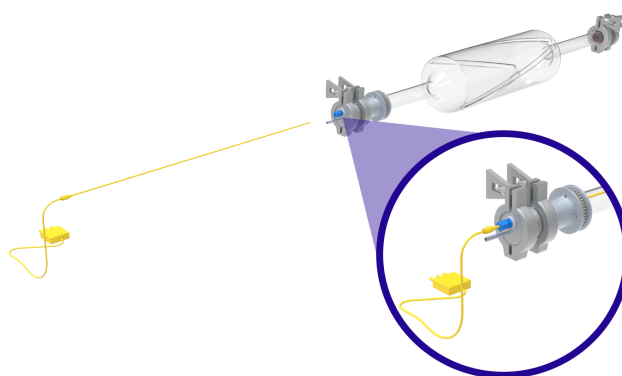

- Connect the end of the thermocouple lead to the socket on the inside of the end guard.
- Secure the probe thermocouple cable to the silicone gas inlet hose using the reusable cable ties provided.

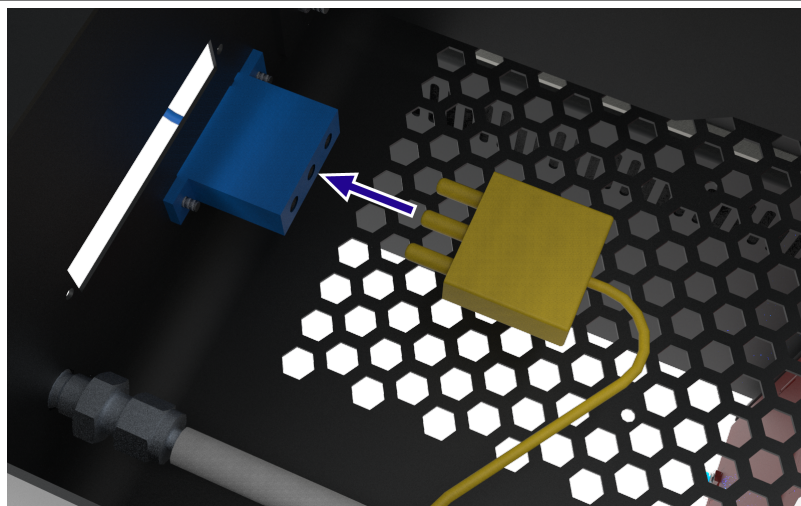

- Connect the male end of the thermocouple lead from the end guard to the socket at the rear of the furnace body.

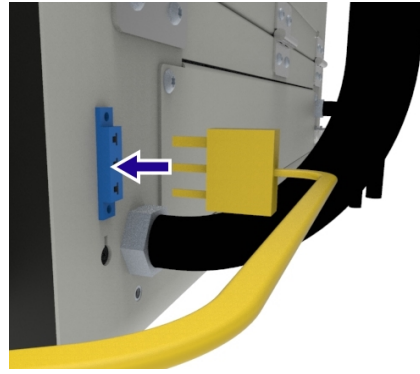

Note: To reduce the risk of tangling or damaging the thermocouple, always disconnect the lead before removing the vessel and withdrawing the thermocouple.

Note: Before operation, always check that the thermocouple cable is not at risk of becoming tangled or caught in any moving parts.

7.0 Installation

7.1 Manual Handling



Refer to the "Specifications" section of this manual for product weights and dimensions.



Mechanical lifting equipment may be necessary!

Consult personnel responsible for health and safety before attempting to move this product!

It is the responsibility of the customer to provide any mechanical lifting aids, such as pallet trucks, forklifts or cranes, and to ensure that all operators of such equipment are fully trained and qualified.



All manual handling must be carried out according to local health and safety guidelines.

7.1.1 Sling Guides

Attached to the underside of the furnace are two brackets. These brackets act as guides for any straps or slings placed under the furnace to assist with manual handling procedures.

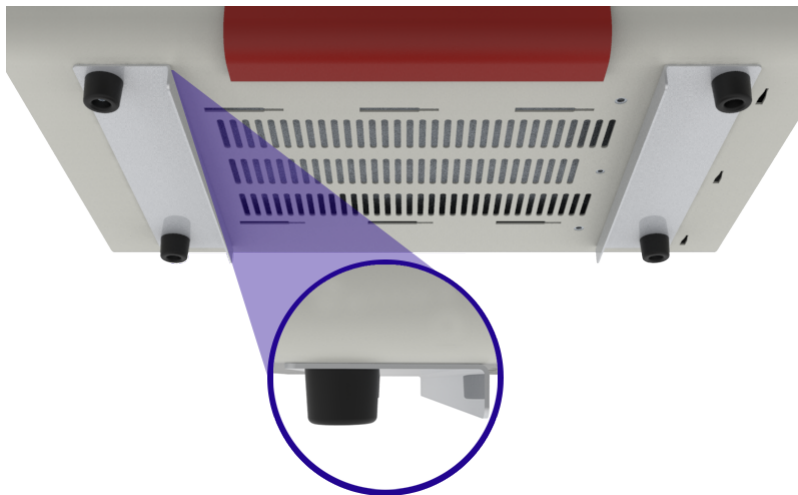

Note: The customer is responsible for all manual handling procedures performed on their own premises.

7.2 Unpacking

Note: Check that all items intended for delivery are present and undamaged before proceeding to install the product.

The product is delivered secured to a pallet for safety and manoeuvrability. It is advised that the product is left on the pallet until it has been moved as close as possible to its intended installation location.

- If the furnace is intended to be mounted on a table or workbench, use appropriate lifting equipment to lift the pallet up to bench height.
- Ensuring that the product is stable and secure, remove any straps retaining the product to the pallet.
- Carefully slide the product off the pallet and onto the bench.



Note: Check that all packaging material has been removed from inside and around the product.

7.3 End Guard Installation

The rotating drive mechanism is contained within specially adapted end guards, that attach to the ends of a TS furnace.

The end guards are supplied in four pieces and are designed to fit at specific positions on the furnace to allow for gas and electrical connections. Each end guard section has hooks with locate into slots on the furnace end plates.

The end guards at the left-hand side of the furnace contain the main drive system and are fitted with a magnetic safety switch that will stop the movement of the gears when the furnace is opened.

The end guards on the right hand side contain rotation guide wheels to ensure smooth rotation of the vessel.

To install the end guards:

- Insert the hooks of the end guard into the slots at the end of the furnace end plate, and secure them with a single screw.

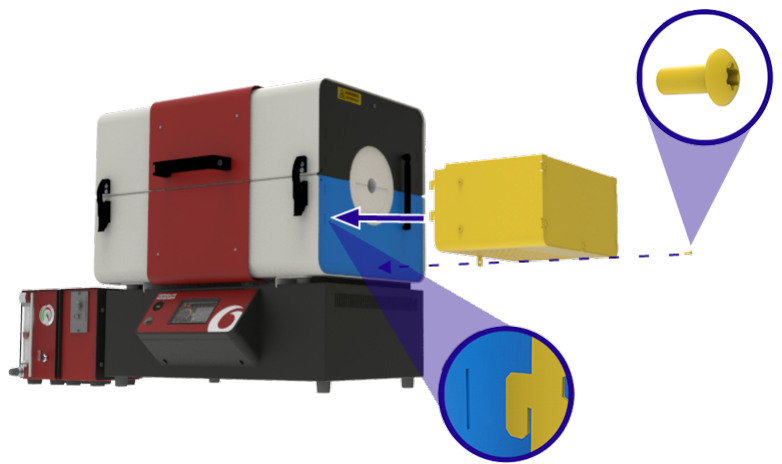

- Repeat this process for both the upper and lower halves at either side of the furnace.

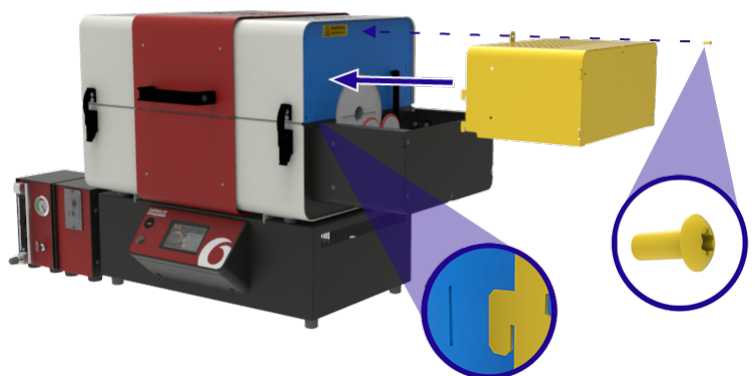

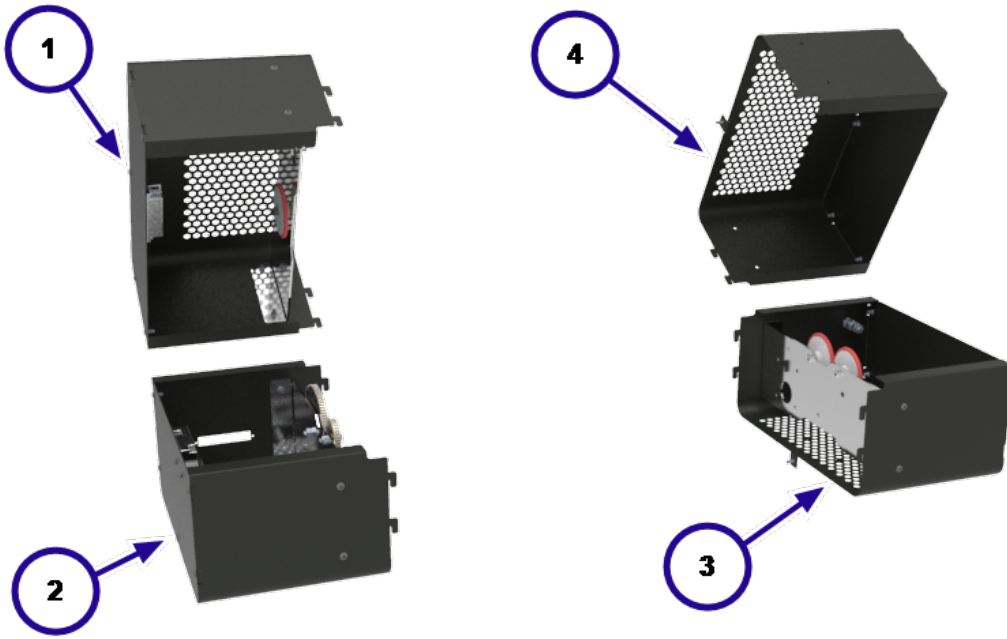

1	Upper Left-hand End Guard
2	Lower Left-hand End Guard
3	Lower Right-hand End Guard
4	Upper Right-hand End Guard

7.4 Lid Prop

For additional safety whilst performing maintenance procedures that require the removal of the pneumatic struts, this product is supplied with a specially designed lid prop.

The lid prop is fixed to the inside of the control box back panel.



Note: Disconnect the product from the electrical supply before carrying out any maintenance procedures.

To retrieve the lid prop:

- Locate the electrical component access panel at the rear of the control box.
- Remove all screws securing the panel to the control box.

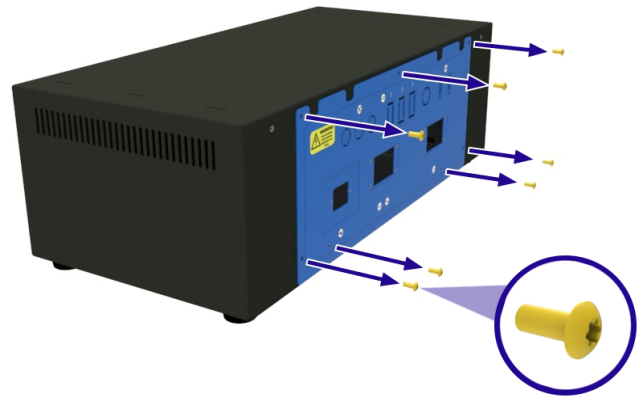

- Carefully slide the panel out of the control box, and disconnect the earth connection, taking care not to disconnect or damage any wiring.

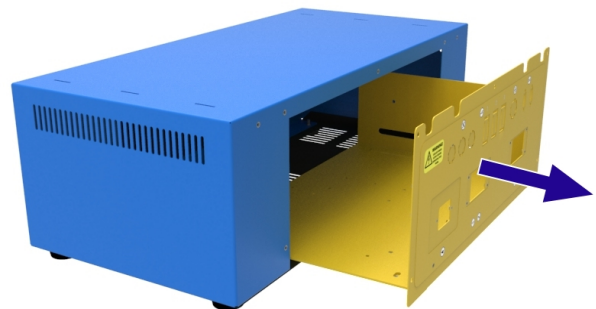

- Remove the two screws securing the lid prop to the electrical component access panel. Hold the lid prop whilst removing the screws to ensure that it does not fall onto and damage electrical components.
- Remove the lid prop from the control box and refit the electrical component access panel.

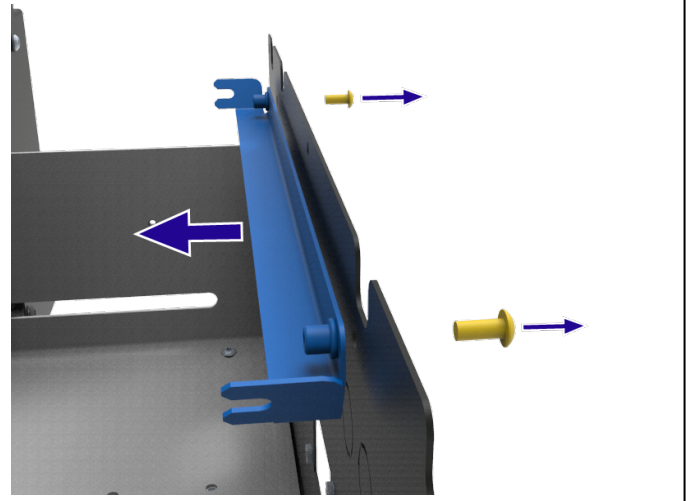

To securely insert the lid prop:

- Open the furnace.
- On the near right-hand side of the upper and lower insulation assemblies, carefully loosen the screws holding the insulation assemblies in place.

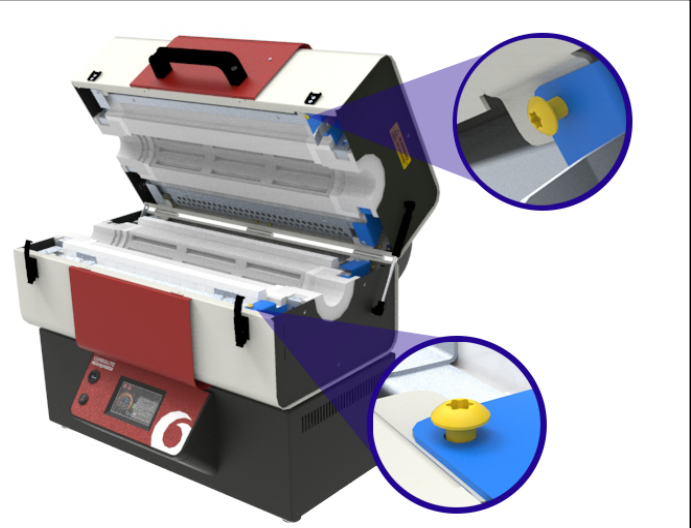

- Hook the end of the lid prop underneath the head of the screws and retighten them to secure the prop in place.
- Check the prop is secure before removing any pneumatic struts or proceeding with any maintenance tasks.

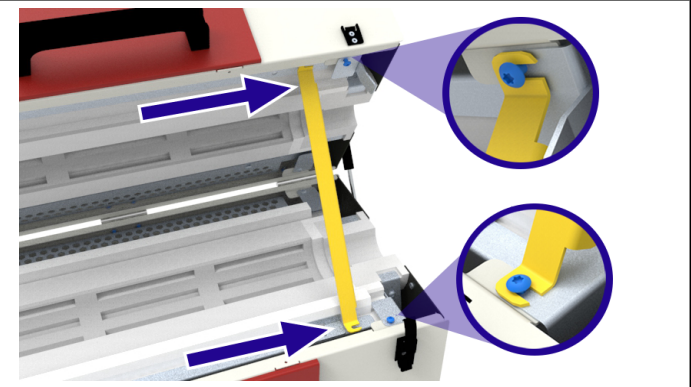

7.5 Pneumatic Strut Replacement

To support the lid of the furnace when opened, a pneumatic strut is fitted at either end of the furnace to limit the opening angle to 60°.

To replace the pneumatic struts:

- Remove the furnace end guards (if fitted).
- Open the tube furnace and insert the lid prop to support the upper half.
- Using a small flat-headed screwdriver, gently prise away the small metal clips at the ends of the pneumatic struts, ensuring that the clip is not fully detached from the joint.

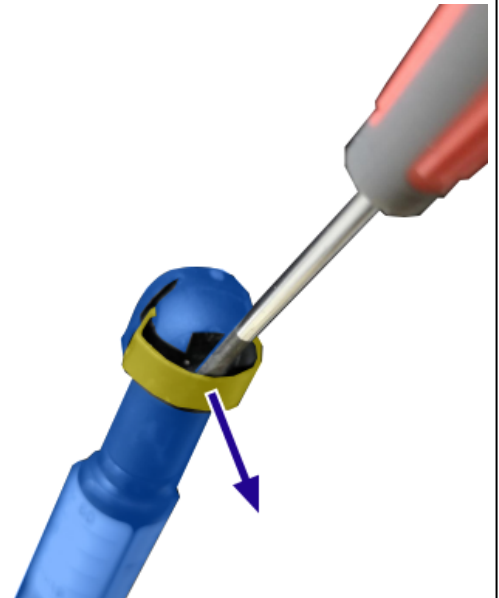

- Carefully pull the pneumatic strut away from the furnace end plate
- Check that the ball joint connecting the pneumatic strut to the furnace end plate is sufficiently lubricated.
- Push the replacement pneumatic strut into position, ensuring that the strut is of the same force rating (N) as the one that was removed. Check the label on top end of the strut.
- Refit the furnace end guards.



7.6 Insulation Collar Replacement



Note: Disconnect the product from the electrical supply before carrying out any maintenance procedures.



Note: This component is made from refractory ceramic fibre. Wear appropriate PPE.



Please refer to section 2.4 for more information

Note: Remove the work tube / vessel before proceeding with the following maintenance procedure.

Replacement insulation collars are supplied in sets of four. Each insulation collar is identical so can be fitted at any appropriate position within the furnace.

To replace the insulation collars:

- If fitted, remove the furnace end guards (see section 0.17.3).
- Open the furnace and insert the lid prop (see section 7.4).
- Remove the pneumatic strut(s) (see section 7.5).

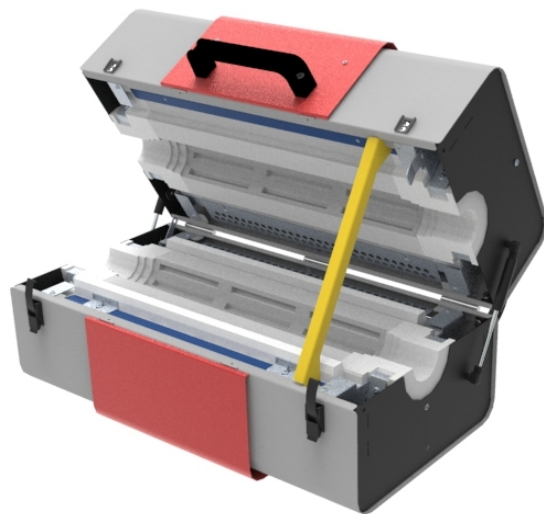

- Using a flexible 8mm hexagon nut driver, loosen the M5 flange nuts holding the furnace end plate in place.
- At the rear of the furnace, remove the two screws securing the end plate in position.

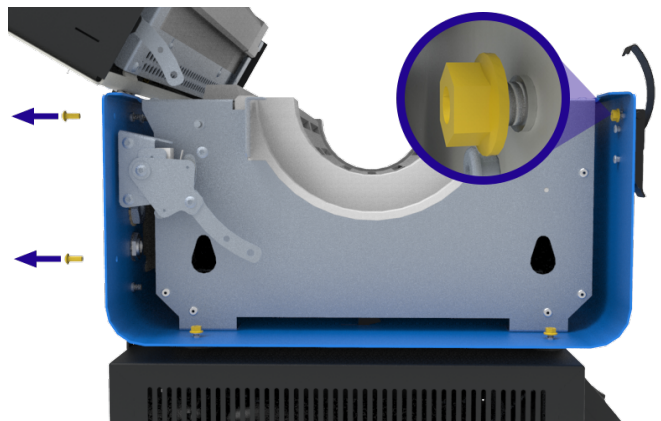

- Gently slide the end plate away from the furnace to provide an accessible gap. It is not necessary to remove the end plate completely.

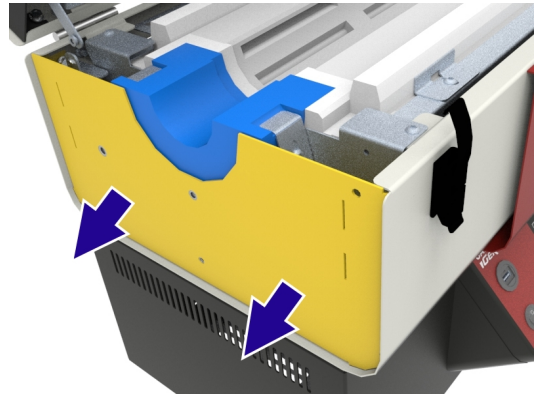

- Remove the M5 screw securing the insulation collar bracket in position.

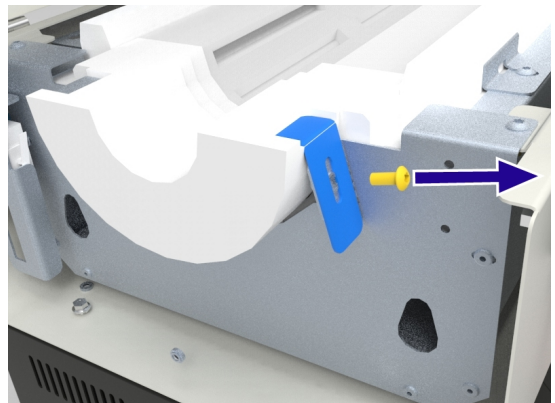

- Remove the bracket.

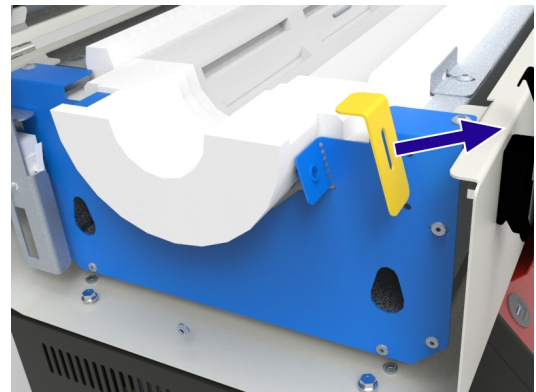

- Carefully rotate and lift the old insulation collar out of position.

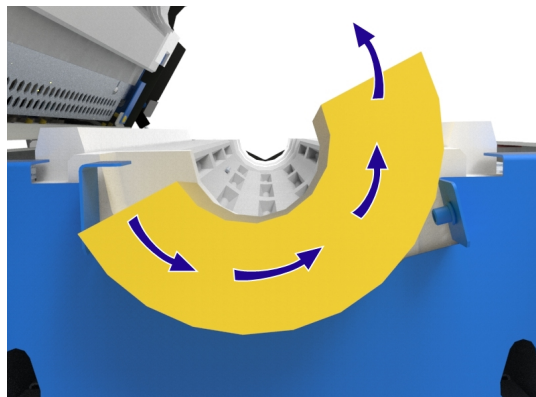

- Carefully insert the new insulation collar, ensuring that the groove on the flat face of the collar fits under the fixed bracket .

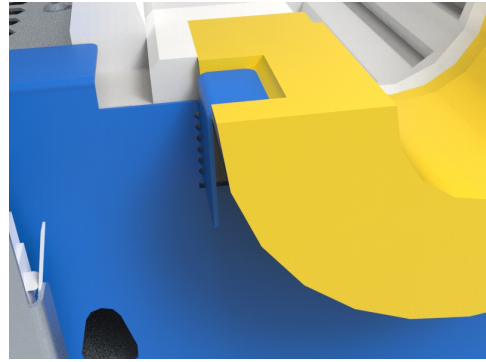

- Refit the insulation collar bracket and tighten it securely onto the groove on the insulation collar. You may need to apply some pressure to the bracket as you tighten the screw to ensure a suitably secure grip.

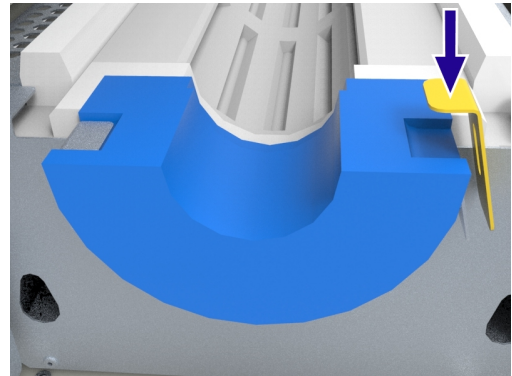

- Push the furnace end plate firmly back into position so that it presses against the insulation collar.

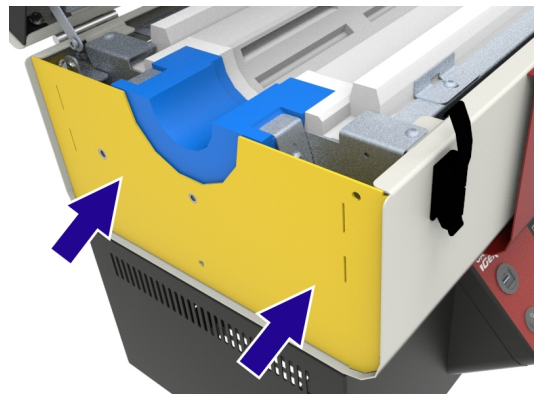

- Secure the end plate by tightening the flange nuts to 4Nm (Newton Metres of torque).
- At the rear of the furnace, replace the two screws securing the end plate in position.

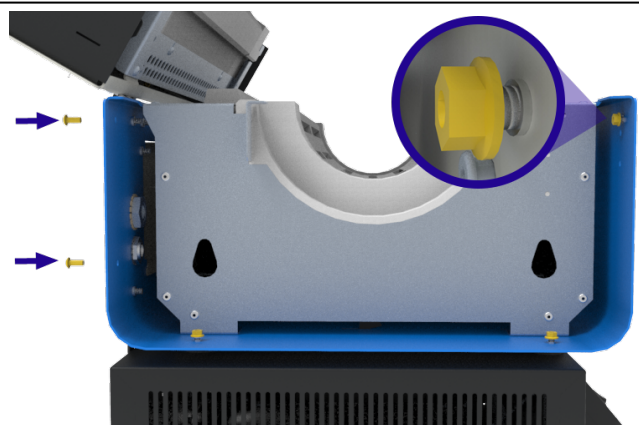

- Refit the pneumatic struts, then remove the lid prop and close the furnace.
- Check that the insulation collars are properly aligned before recommissioning the furnace.

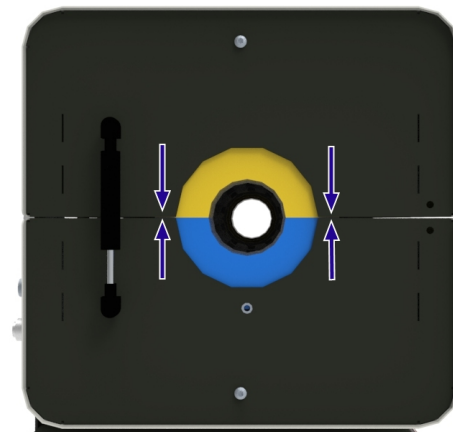

7.7 Loading the Vessel



Note: It is recommended that the furnace is only operated using the Carbolite Gero supplied quartz vessel.



Note: The vessel is only suitable for processing granular or powdered samples. Always observe the maximum volume and weight limits

1. Ensure that both the furnace and vessel are cold.
2. Remove the vessel from the furnace.
3. If already fitted, remove the end plates from the end seal assembly.
4. Carefully incline the vessel.
5. Using a suitable funnel, pour in the sample material.
6. Gently tap the quartz vessel to encourage powder to slide down into the wider processing section of the vessel.

7.7.1 Vessel Parts

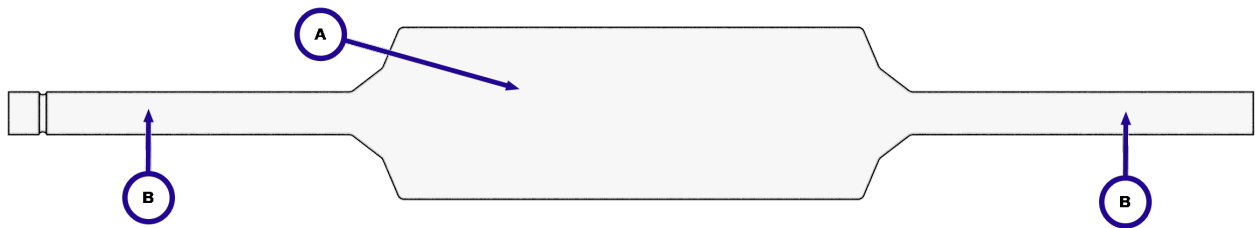

A	Processing section
B	Support tube section

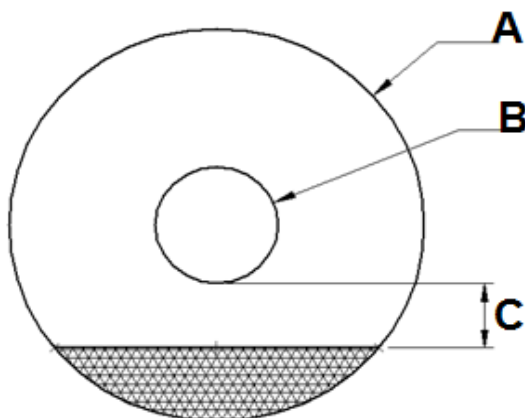

End View of Vessel

A	Internal diameter of processing section	122mm
B	Internal diameter of support tube section	29mm
C	Minimum recommended distance between bottom of support tube section and top of levelled sample	20mm

Note: Value C corresponds with the vessel being filled up to the maximum recommended volume capacity stated in section 4.0.

7.8 End Seal Installation

In order to maintain a modified atmosphere within the vessel, end seals are required. The TSO has different end seals for either end of the vessel, with one incorporating gear teeth that interface with the drive mechanism.

Note: To enable use within an air atmosphere, parts 4, 5, 6 and 7, along with one clamp (2) are always supplied. These should only be fitted to the left hand side of the vessel. All other parts displayed below are only necessary if a gas atmosphere is required inside the vessel.

Left

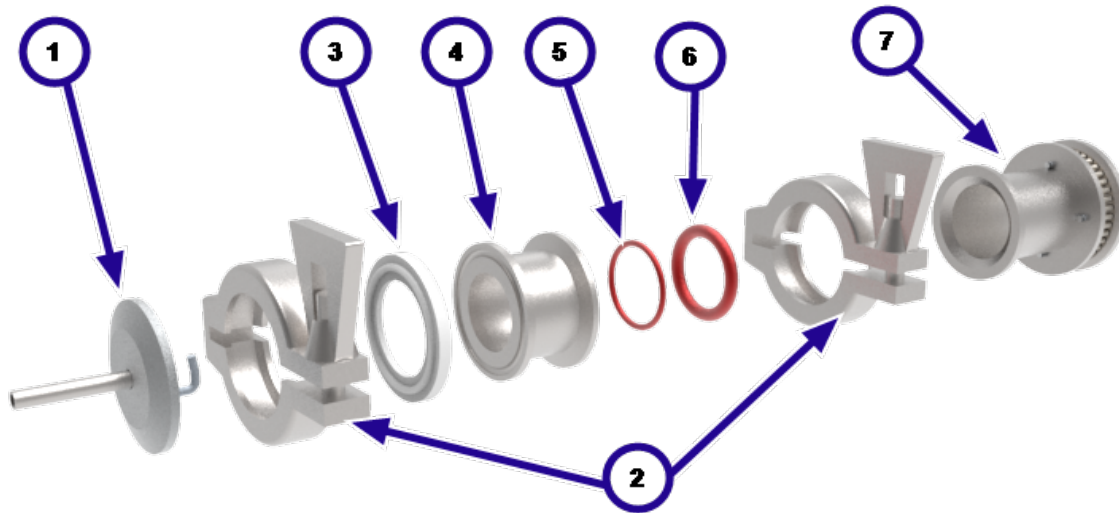

1	End plate
2	Clamp
3	End plate seal
4	Seal sleeve
5	Seal sleeve O-ring
6	O- ring seal
7	Geared sleeve
8	Seal plate

Right

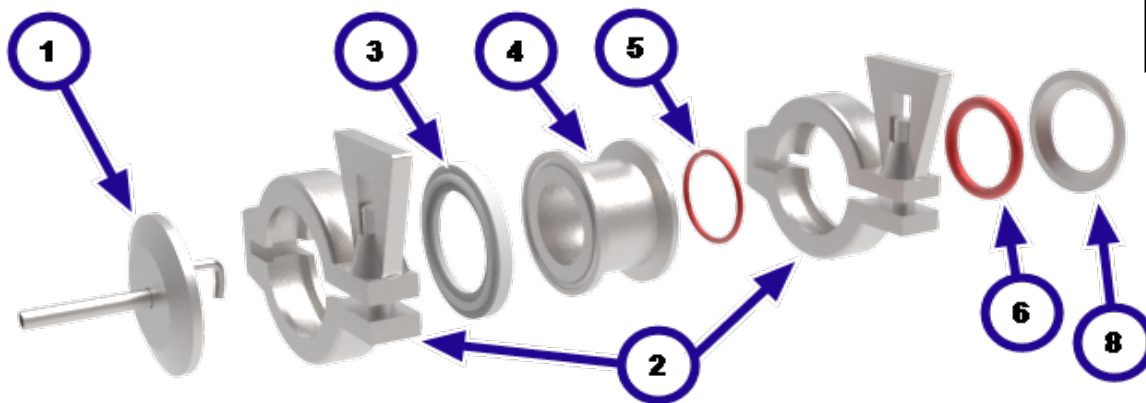

7.8.1 Left-Hand Side End Seal

- Place the geared sleeve over the end of the vessel as shown.



- Push the o-ring seal over the end of the vessel and into the groove.



- Insert the small seal sleeve O-ring into the seal sleeve.

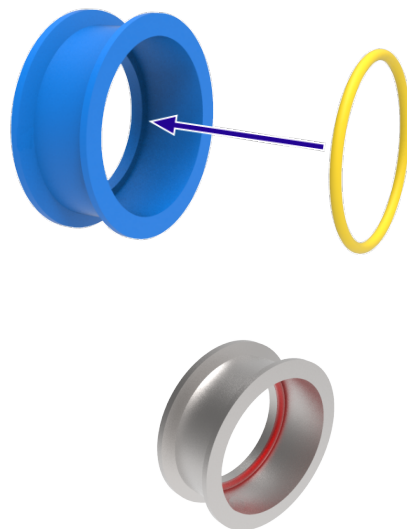

- Slide the seal sleeve over the end of the vessel until the end is flush against the end of the gearing sleeve.



- Secure the seal sleeve and gearing sleeve in position with a clamp.
- Carefully tighten the clamp so that the seal sleeve and gearing sleeve do not slip around the vessel.



- Push the end plate seal onto the groove on the end of the seal sleeve.



- Push the end plate onto the end of the assembly. It may be necessary to hold it in position until it is secured with a clamp



- Secure the end plate to the end of the seal sleeve with the remaining clamp.



7.8.2 Right-hand Side End Seal

Note: The end seals on the right hand side of the vessel are only required if a gas atmosphere is to be contained within. If operating the furnace under an air atmosphere, then no additional sleeves or seals need to be fitted to the right hand side of the vessel.

- Place the seal plate over the end of the vessel as shown.



- Push the o-ring seal over the end of the vessel.



- Insert the small seal sleeve O-ring into the seal sleeve.

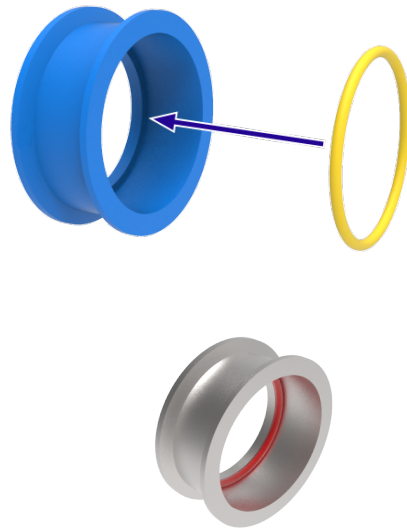

- Slide the seal sleeve over the end of the vessel until rests against the end of the tube.



- Secure the seal sleeve and seal plate in position with a clamp.
- Carefully tighten the clamp so that the seal sleeve and seal plate do not slip around the vessel.



- Push the end plate seal onto the groove on the end of the seal sleeve.

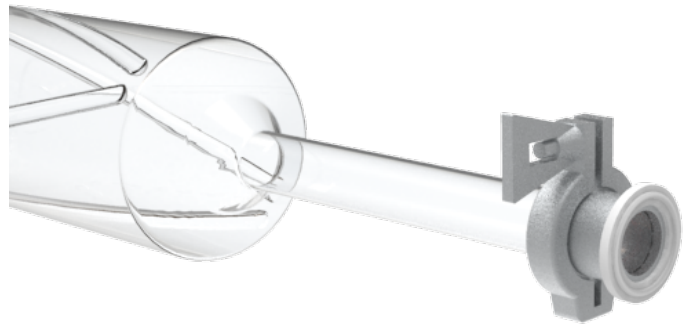

- Push the end plate onto the end of the assembly. It may be necessary to hold it in position until it is secured with a clamp



- Secure the end plate to the end of the seal sleeve with the remaining clamp.



7.8.3 Probe Thermocouple End Plate

If the TSO has been ordered with a probe thermocouple or cascade control functionality, the left hand side end plate will include a thermocouple gland.

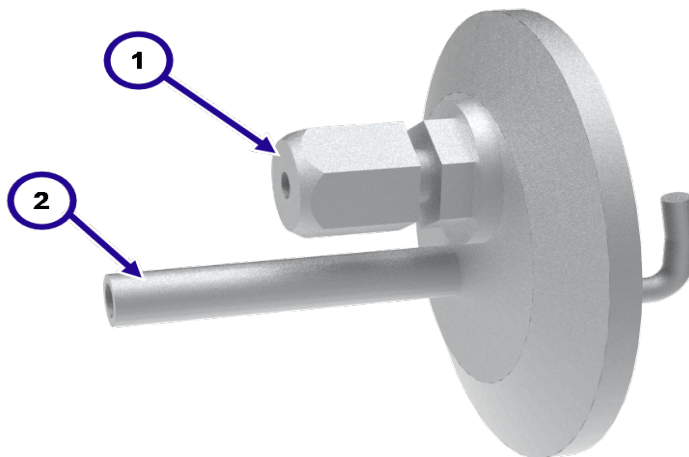

1	Thermocouple Gland
2	Gas Inlet

7.9 Lubricating Gears

To reduce the risk of the drive system seizing over time / prolonged use, all gears must be sufficiently lubricated using an anti-seize compound at all times.

- Lubricate the drive system gears with anti-seize compound, ensuring that the compound is applied to the teeth of the gears.

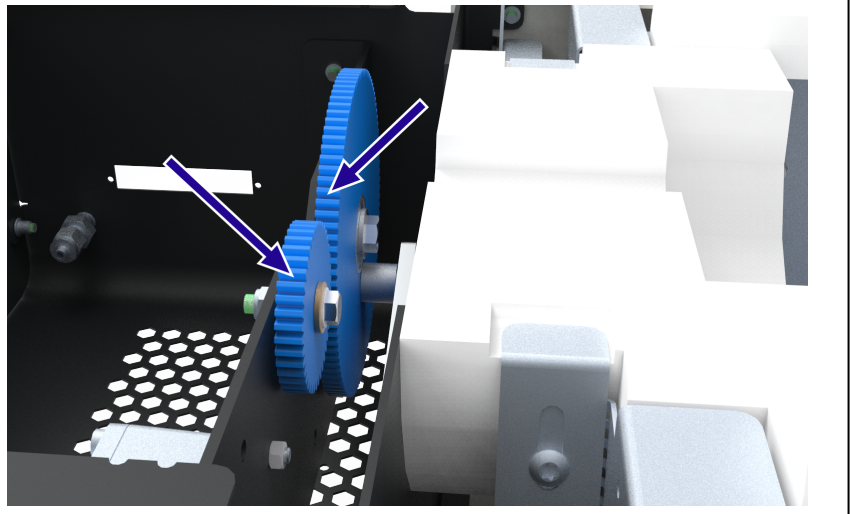

7.10 Installing the Vessel



Note: Ensure that the furnace is cold before attempting to install the vessel.



Note: Disconnect the product from the electrical supply before carrying out any maintenance procedures.

- Open the furnace.
- Lower vessel into position, ensuring that the geared sleeve is fully located onto the gears of the drive system.

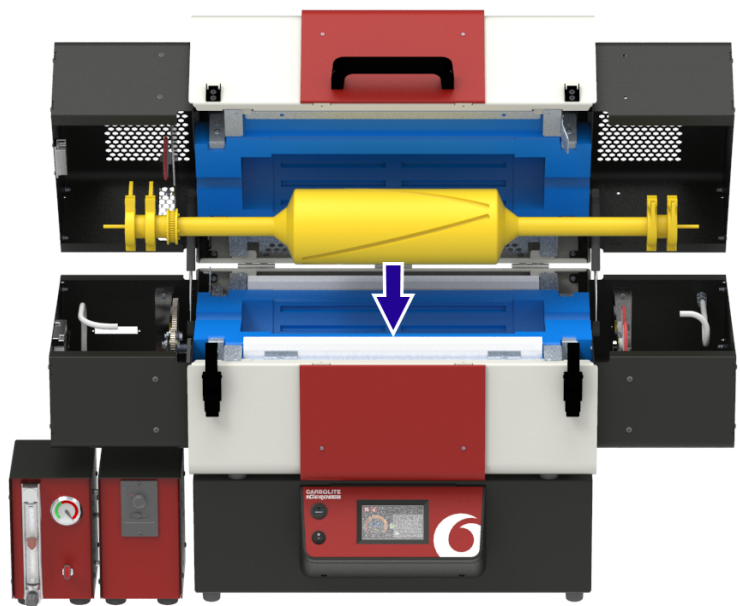

- The idler wheel in the top left guard should rest gently on the geared sleeve when the lid is closed. This ensures the gears stay engaged.



- To check that the idler wheel is in the correct position, open the furnace and remove the five screws holding the end plate of the upper left-hand end guard in position.

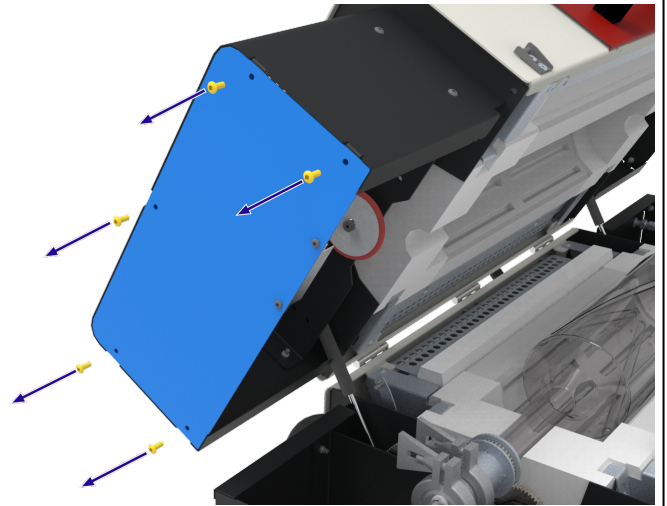

- Remove the end plate. The top half of the end guard safety switch is attached to the end plate.
- Close the furnace.

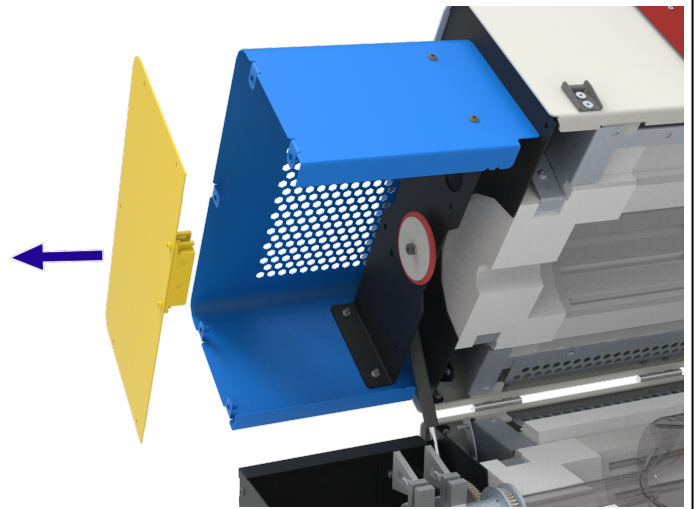

- Check that idler wheel is in the correct position by gently attempting to lift the reactor assembly. It should only move up by a maximum of 1mm, squashing the rubber tyre on the idler wheel in the process.
- If the reactor cannot be moved at all and the tyre is visibly squashed, the idler wheel may be too low and require adjustment.

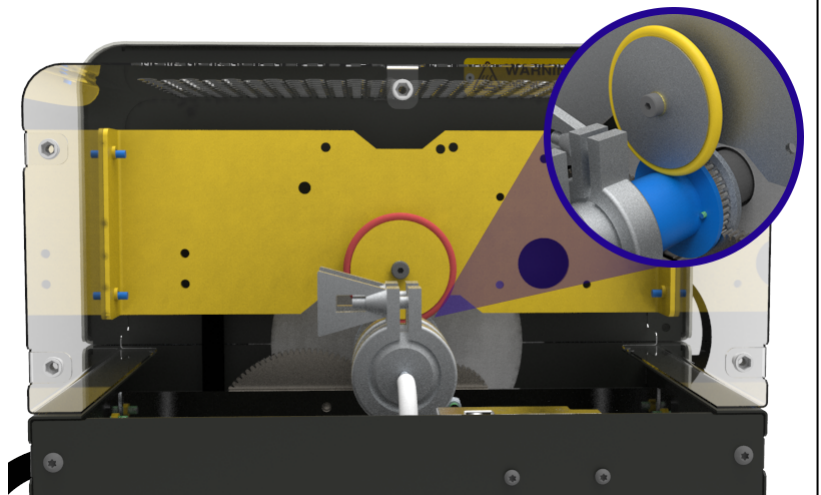

- To adjust the position of the idler wheel, loosen the four screws (two at the front of the end guard and two at the rear). The plate to which the idler wheel is attached will then be able to move by a few millimetres.

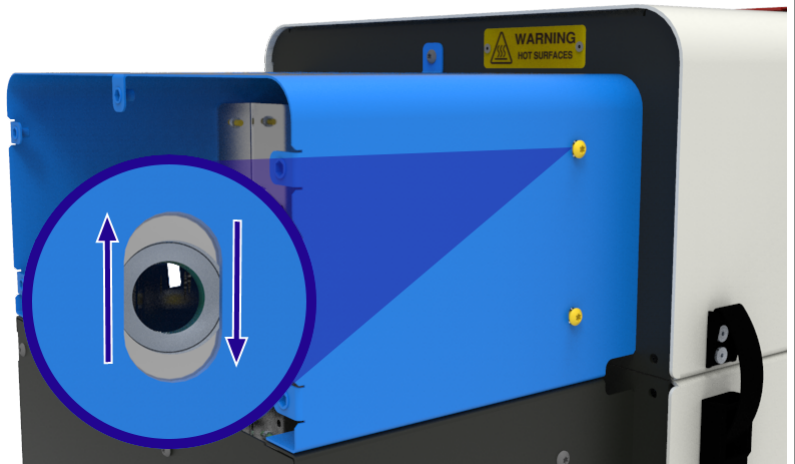

- Allow the idler wheel to slide into the correct position, resting lightly on the geared sleeve.
- Retighten the four screws on outside of the end guard to secure the wheel in place.
- Check the positioning again by gently lifting the reactor assembly, and make further adjustments if required.
- Once the idler wheel is secured in the correct position, replace the end plate of the end guard.

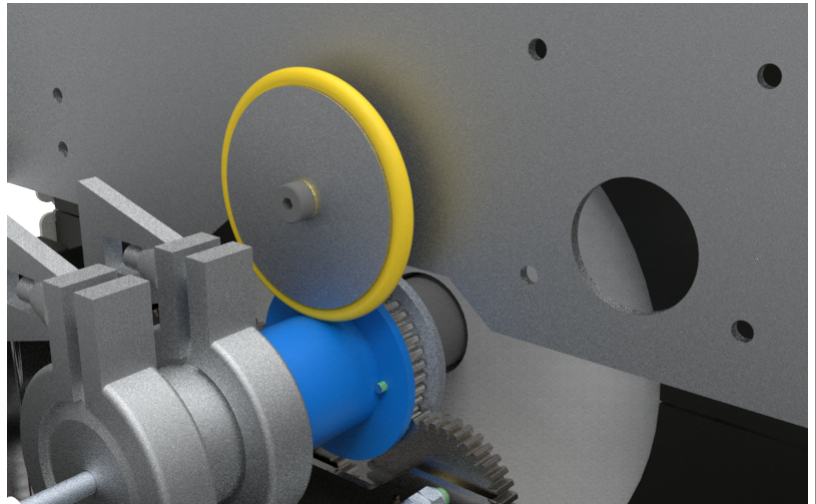

7.11 Gas Supply Connections

Note: Gas supply connections are only fitted to the end guards if ordered with the TSO Gas Connection Kit.

Gas inlet and outlet connectors are provided pre-fitted to the end guards. The inlet is located at the rear of the lower left-hand side end guard, and the outlet is located at the rear of the lower right-hand side end guard.

- Loosen the nut on the 6mm compression fitting and fully insert the end of the braided hose.
- Tighten the nut until finger-tight, then use a spanner for a further 1.25 turns to secure the hose in place.

Note: If ordered with the inert gas package option, the outlet from the gas package is connected to the inlet on the TSO end guard. For further details on connecting Carbolite Gero gas systems, please refer to the separate manual provided.

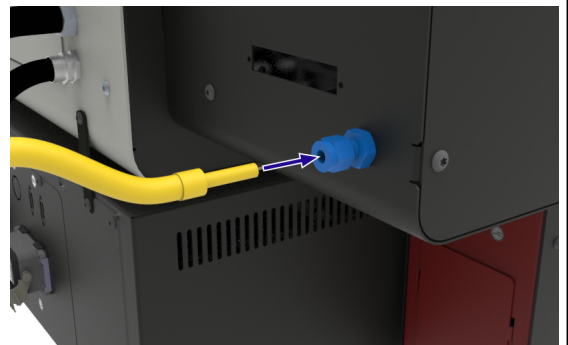

- Push the silicone hose provided, over the gas inlet pipe on the vessel end plate. To ensure that it does not come loose during operation, the hose should be pushed at least 20-30mm onto the inlet pipe.

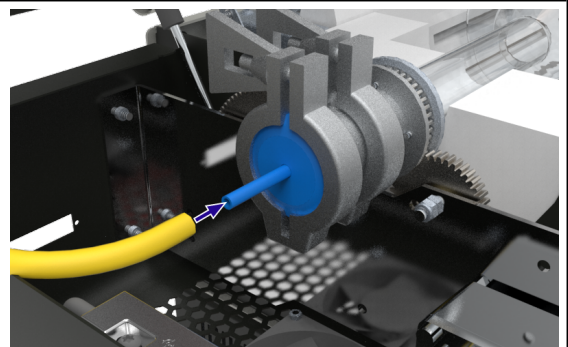

- A 6mm compression fitting is available on the gas outlet. Use this to connect additional gas piping for either safe disposal of exhaust gas or to supply samples to analytical equipment.
- Loosen the nut on the 6mm compression fitting and fully insert the end of the additional piping.
- Tighten the nut until finger-tight, then use a spanner for a further 1.25 turns to secure the pipe/hose in place.

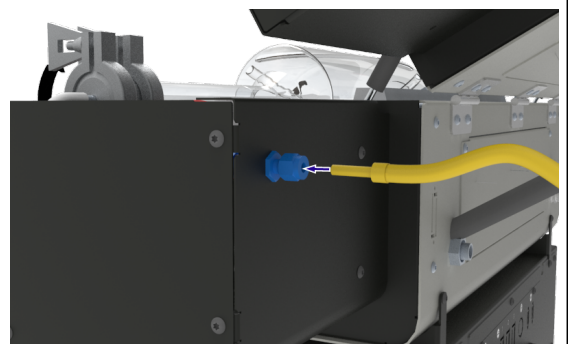

- Push the silicone hose provided, over the gas outlet pipe on the vessel end plate. To ensure that it does not come loose during operation, the hose should be pushed at least 20-30mm onto the inlet pipe.

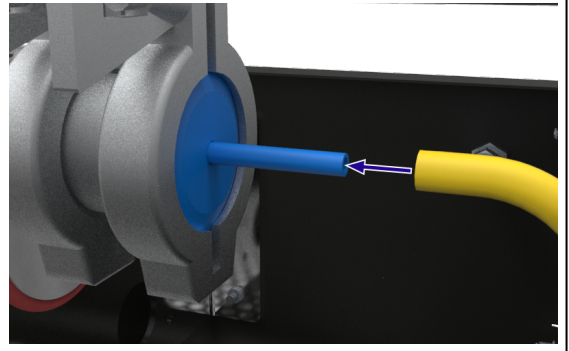

7.12 Electrical Supply Connections

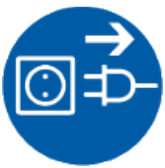

When connecting the product to the power supply, the plug or isolating switch should be accessible, easy to remove / operate, and within reach of the operator.

- The speed control box has its own dedicated power supply, separate from the main furnace power supply.

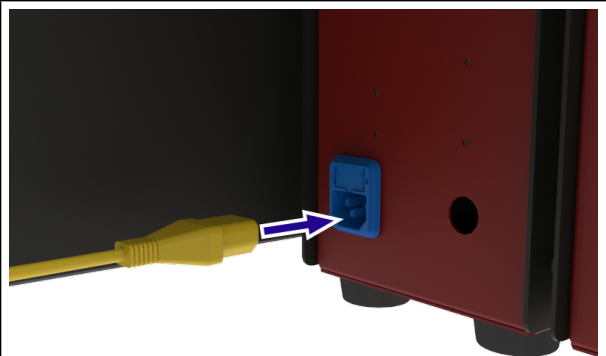

- Power to the drive system is provided via a connection to the speed control box.

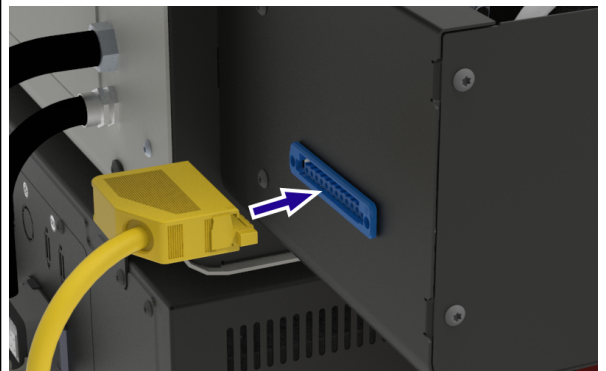

7.13 Electrical Connections



For products supplied without pre-fitted plugs, it is recommended that all electrical connections are carried out by a qualified electrician.

The product covered by this manual normally requires a single phase A.C. supply, which may be "Live to Neutral non-reversible", "Live to Neutral reversible" or "Live to Live". Some models may be ordered for 3-phase use, which may be with or without neutral.

Check the product rating label before connection. The supply voltage should correspond with the voltage on the label and the supply capacity should be sufficient for the current on the label.

The supply should be fused at the next size equal to, or higher than the current on the label. This manual contains a table of the most common fuse ratings.

- When the mains cable is factory-fitted / supplied, internal fuses are also fitted. It is essential that the operator ensures that the power supply is correctly fused.
- Products with a factory fitted supply cable but without a plug are designed to be wired directly to an isolator or fitted with a line plug compliant with the customer's local regulations and supply.
- Products without a factory-fitted supply cable require a permanent connection to a fused and isolated supply. The product's electrical component access panel should be temporarily removed, and connections made to the internal terminals / fuse holder.

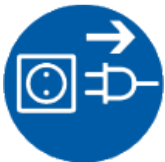

When connecting the product to the power supply, the plug or isolating switch should be accessible, easy to remove / operate, and within reach of the operator.

Note: The supply MUST incorporate an earth (ground).

7.13.1 1-Phase Connections

Terminal Label	Cable Colour	Supply Type & Connection	
		<i>Live - Neutral</i>	<i>Reversible or Live - Live</i>
L1	Brown	to live	to either power conductor (for USA 200-240 V, connect L1)
N / L2	Blue	to neutral	to the other power conductor (for USA 200-240 V, connect L2)
PE	Green / Yellow	to earth (ground)	to earth (ground)

7.13.2 3-Phase Connections

Terminal Label	Cable Colour	Connection
L1	Black	to phase 1
L2	Black	to phase 2
L3	Black	to phase 3
N	Light Blue	to neutral (if fitted)
PE	Green / Yellow	to earth (ground)

7.14 Mains Supply Cable

IEC	3-core, 1.5mm ² rated to 16 Amp, 250 VAC
------------	---

7.15 Connecting a Supply Cable to Internal Terminals



For products rated above 16 Amps supplied without pre-fitted plugs, all electrical connections should be carried out by a qualified electrician.

- Locate the electrical component access panel at the rear of the control box.
- Remove all screws securing the panel to the control box.

- Carefully slide the panel out of the control box, and disconnect the earth connection, taking care not to disconnect or damage any wiring.

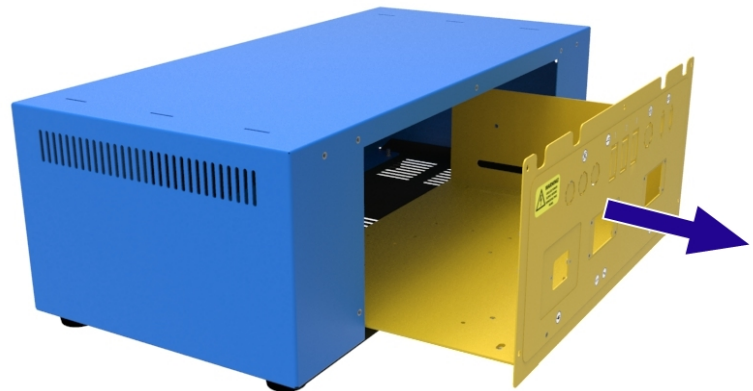

- On the electrical component access panel, fit an appropriate sized gland for the cable required.
- To connect the Live and Neutral wires (e.g. L1, N/L2), loosen the screw on the top of the fuse holder and fully insert the wire into the slot. Tighten the screw to secure the wire in place.
- To connect the earth (PE) wire, insert an appropriately sized flat blade screwdriver into the slot on the top of the terminal and fully insert the wire into the round hole. Remove the screwdriver to secure the wire in place.

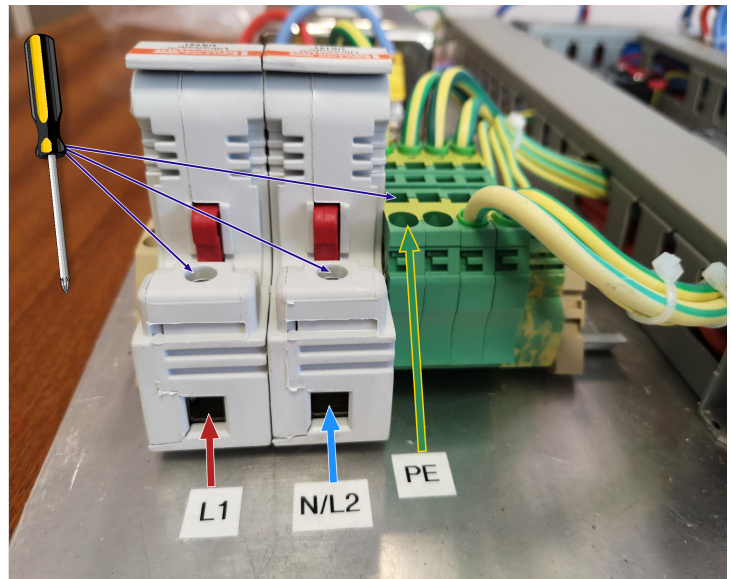

Note: The number of Live terminals will differ depending on the product and power supply configuration ordered.

8.0 Commissioning

Note: This equipment should not be put into use until it has been commissioned by a competent person in accordance with the instructions contained within this manual, and any local regulations. Carbolite Gero offer an installation and commissioning service. Please contact Carbolite Gero Service for details.

8.1 Pre-Commissioning

When the product is cold and disconnected from the power supply, visually check the following:		Checked by:
Siting / Securing	Check that the product is placed on a secure, level surface and cannot topple over when both open and closed.	
Packaging	Check that all packaging material has been removed from inside and around the product.	
General Condition	Check that no damage has occurred during delivery and siting.	
General Access	Check that there is sufficient clearance around the top and all sides of the product when both open and closed. Refer to the "Installation" section of this manual for required clearance dimensions.	
Ventilation	Check that the product has been installed in a well ventilated area.	
Extraction	If a room extraction system is in operation (not supplied by Carbolite Gero), check that there is sufficient clearance between the extraction hood and the product. Refer to the "Installation" section of this manual for required clearance dimensions.	
Thermal Insulation	Check for signs of damage, deterioration, excessive cracking or missing insulation material. (Please refer to section 10.7)	
Safety Guards and Panels	Check that all covers, safety guards and access panels are securely fitted.	
Door Operation	Check that the door / top of the furnace has not become misaligned during transit. Check that the furnace opens easily and that all hinges, pneumatic struts and latches are operating as intended. The furnace should not immediately fall shut when the operator releases the handles.	

Electrical Supply	<p>Check that the voltage stated on the product rating label matches the electrical supply of the installation site.</p> <p>If a mains cable has been provided, check that it is securely attached to/ plugged into the product.</p> <p>If the product is rated above 16 Amps and requires a separate mains cable to be wired directly into the product, check that the cable is rated correctly and fitted by a qualified electrician.</p>	
Earth Connection	Check that an earth connection has been made. All removable panels should be earthed.	
Gas Connections / System (if fitted)	If the product was ordered with ancillary equipment for working with gases e.g. inert gas package, gas safety system etc. check that all connections have been made as detailed in this manual.	
Drive System	Check that the drive system is sufficiently lubricated and free of debris/obstructions.	
Rating Label / Warning Labels	Check that all labels are fitted and all information is legible. (See section 3.2)	

8.2 Commissioning - Initial Function Checks



Note: Do not operate the furnace without first installing a vessel. Operating without a vessel exposes the operator to live electrical components (heating elements) and subsequent risk of electric shock.

When the product has been connected to the mains electrical supply, check the following:		Checked by:
Instrument Switch	Check that when turned to the ON position, the temperature controller(s) illuminates.	
Main Temperature Controller	<p>Check that the temperature controller is functioning correctly by setting a setpoint or starting a program as instructed in the controller manual instructions. The product should begin to heat to the set / programmed temperature.</p> <p>The furnace is despatched with all controller setpoints set to 0°C to ensure that the product does not unintentionally start heating during initial commissioning checks.</p>	
Safety Switch	While it is heating and the temperature is below 200°C, open the furnace and check that the power to the heating elements cuts off. The heater lamps at the rear of the control box should stop illuminating. The product should stop heating, and the vessel should stop oscillating if the safety switch is functioning correctly.	

	<p>Note: DO NOT open the furnace at high temperatures. Doing so may cause the vessel to shatter.</p>	
Over-Temperature Controller (if fitted)	Set the over-temperature setpoint lower than the temperature displayed on the main temperature controller. The over-temperature should go into an alarm state and the product should stop heating.	
Gas connections / system (if fitted)	<p>Note: Please refer to the separate Inert Gas Package / Laboratory Gas Safety System manual for details.</p> <ul style="list-style-type: none"> • Check that the supply pressure is regulated to a maximum of 0.05 bar (50 mbar). • If an over-pressure valve is fitted ensure that it is directed away from both operators and sensitive equipment. • Check that all the connections to the gas supply are secure and that gas flows correctly through the system e.g. flowmeters register, any solenoid valves open. 	
Drive System	<ul style="list-style-type: none"> • Check that the drive system is sufficiently lubricated and free of debris/obstructions. • Check that the gears of the drive system fully rotate when powered on. • Check that the oscillation speed is set as required by adjusting the speed selector on the drive speed control box. • Fit the vessel and check that it oscillates back and forth as expected. 	
Vessel	<ul style="list-style-type: none"> • Check that the vessel is fitted before operation. • Check that the vessel has room to expand/contract during heating. The vessel must be a loose fit inside the furnace. 	
Gas package (optional)	<ul style="list-style-type: none"> • If required, check that the insulation plugs / radiation shields are fitted. • Check that the end seals are securely fitted. 	

9.0 Temperature Controller

If this product is fitted with a temperature controller, instructions are provided separately.

10.0 Operation

10.1 Operating Cycle



Note: The customer is responsible for conducting their own risk assessment prior to operating this product.



Note: Ensure that all pre-commissioning and commissioning checks have been performed before proceeding with normal operation of this product. Please refer to section 8.0 for a list of recommended checks.



Note: Always ensure that the operator is wearing the appropriate PPE when operating this product. Please consult your Health and Safety personnel and refer to section 2.0.

1. After installing all equipment and accessories as required, connect the product to the electrical supply.
2. Turn on the instrument switch to activate the temperature controllers. The controllers will illuminate and go through a short test cycle.
3. Turn on the power switch at the back of the speed control box, and adjust the dial until the vessel begins to oscillate at the desired speed.
4. If an inert atmosphere is required, it is recommended that the vessel is first purged with inert gas prior to heating, and whilst the vessel is oscillating, to ensure that any gas trapped between the sample grains is released.
 - a. A high initial gas flow rate is known as the "purge" flow rate, and is intended to displace the volume of oxygen within the vessel. It is recommended that the atmosphere inside the vessel is exchanged (purged) at least 5 times in order to ensure the lowest possible oxygen levels inside the vessel.
 - b. To maintain low levels of oxygen, a constant flow of gas is required during sample processing. This lower flow rate is known as the "process" flow rate, and helps reduce overall gas consumption without compromising the purity of the atmosphere inside the vessel.

Note: The purge and process flow rates are dependent on the customer's process requirements and not defined by Carbolite Gero.

5. Set up the temperature controllers as required. Please refer to the separate temperature controller manual for details on controller operation.
6. If the product is fitted with over-temperature protection, set the required over-temperature setpoint according to the instructions detailed in the separate controller manual.
7. If a setpoint has been set on the main controller, either manually or via a program, the product will begin to heat up.
8. Diagnostic heater lamps at the rear of the control box will illuminate when the product is heating.
9. Proceed with your heating process.

10. If the product is fitted with over-temperature protection and the over-temperature alarm is triggered, follow the instructions in the separate controller manual to reset and continue with your heating process.
11. To switch off power to the heating elements, reduce the setpoint to 0°C on the main temperature controller.
12. Allow the vessel to continue oscillating until all the equipment has fully cooled.
13. Once cooled, turn off the power at the back of the speed control box to stop oscillation.
14. Switching off the instrument switch will cut power to the heating elements and temperature controller(s).

Note: If the product is to be left switched off and unattended, isolate it from the mains electrical supply.



Note: Do not attempt to speed up the cooling process by opening the furnace. Opening the furnace will stop the product from oscillating, and increase the risk of thermal shock damage to the vessel.

10.2 Safe Operation



Note: DO NOT leave the product operating unattended unless the over-temperature protection option is fitted.



Refer to the "Safety" section of this manual for details on ensuring operator safety.

Explosive materials:



- The furnace must not be used to heat materials that could explode, or that could emit gases that could form explosive mixtures. If the safe heating of a material is dependent on its temperature, only heat these types of materials if the furnace has the optional over-temperature protection device fitted.
- Ensure that the over-temperature device is calibrated and set to an over-temperature safety limit that is appropriate for the material being heated so as to avoid any hazards. If in doubt, seek expert advice before proceeding.
- Customers are responsible for carrying out their own risk assessments on the heating of materials.

Do not operate without a vessel:



- The furnace must not be operated without the correctly sized vessel and corresponding insulation collars.
- If operated without a vessel, it may be possible for an operator to access electrically live heating element coils, which could cause serious injury or death.

Switch off the furnace before loading and unloading:



- The furnace elements must be switched off using the instrument switch when the furnace is being loaded or unloaded.
- The vessel can become electrically conductive at high temperatures. If an element has failed and collapsed onto the vessel, the vessel will become live which could cause serious injury or death.

Opening the furnace at high temperatures:



- DO NOT attempt to install or remove the vessel when the furnace is heating! The vessel should only be installed when the furnace is at ambient temperature.
- It is possible to open the furnace at high temperatures in order to increase the rate of cooling, however this will reduce the working life of both the vessel and the furnace.

10.3 Speed Control Box

The speed control box has its own dedicated power supply, separate from the main furnace, which also provides power to the drive system. Please see section 7.12 for electrical connection details.

The motor speed can be adjusted so that it provides between 1 and 8 complete cycles of oscillation per minute.

Note: If the control knob is moved to far towards the low-speed end of the range there is a risk the motor will stop altogether. Make sure the speed is set significantly above this point.

Speed setting may involve a trade-off between the rate of progress of heat treatment and the risk of carrying product out of the heated zone. Higher rotational speed will typically decrease the processing time, but could cause more powder to become airborne, or a higher rate of out-gassing from the sample.



10.4 Recommendations for Vessel Usage

10.4.1 Running at High Temperatures

- During heating, the vessel will increase in both length and diameter, a process known as thermal expansion. The rate of thermal expansion is dependent on the properties of the vessel material and the temperatures to which it is exposed.
- Unsupported sections of the vessel may experience some drooping malformations when hot, which can stress the material and increase the risk of breakage. This can be mitigated by ensuring that the vessel is continuously oscillating.
- Do not set too high a heating or cooling rate. Despite quartz having a high resistance to thermal shock damage, there is still a risk that the vessel may break if subjected to rapid changes in temperature.



Note: Because the exact details of the customer's process are unknown, it is not possible to account for process-specific wear to the vessel material. The working life of the vessel is variable and depends entirely on the operating temperatures, program ramp rates, and properties of the materials being heated. Subsequently the vessel is classed as a consumable item and is not covered by the standard Carbolite Gero warranty terms.

10.5 Vessel Care (Quartz/Silica)



Note: Quartz vessels are both fragile and expensive, and should be handled with great care.



Note: Although quartz has a high resistance to thermal shock, sudden temperature changes should always be avoided in order to reduce the risk of damage to the vessel.

10.6 Devitrification

Devitrification is a crystallisation process that changes the structure of a material. It is greatly dependent on surface conditions, therefore any contaminants within the furnace atmosphere may cause the quartz (silica) vessel to devitrify at high temperatures.

Note: At 1000 °C only a highly contaminated atmosphere has a noticeable effect, but at 1100 °C the rate of devitrification may become significant. A devitrified vessel will eventually fail. Failure is likely to be by cracking after cooling below 300 °C.

- Impurities such as alkali or alkaline earth ions, which occur in dust and perspiration, should be avoided. It is advisable to handle the vessel with clean gloves or a dry cloth and to touch the central (hot) part as little as possible.
- The silica vessel should be cleaned with pure alcohol and wiped dry with a clean cloth.
- The specific substances used by the customer's process may, of course, be prime causes of devitrification, as they may attack the vessel inner surface chemically and by abrasion. Carbolite Gero can advise, or seek external advice, on specific materials, if requested.

The following lists some elements and compounds known to cause devitrification. The list is not exhaustive.

Severe	Na, Fe, Co, Sn, LiCl, SnCl ₃ , KOH, NaOH, Fluorides, Alkaline & Earth Alkaline Metals and their salts, F ₂
Severe >1000 °C	Mg, Ba, Mn, Cu, Sb, MgO, BaCO ₃ , NaCl, KCl, CsCl, BaCl ₂
Less Severe	Al, As, Sn(OH) ₂ , Ba(OH) ₂ , CaCO ₃ , CaCl ₂
Not known to cause devitrification up to 1100 °C	Ca, B, Ti, Zr, V, Nb, Ta, Cr, Mo, W, Ni, Ag, Zn, Cd, Hg, C, Si, Pb, S, Se, Ir, H ₂ , O ₂ , CaO, Al ₂ O ₃ , SiO ₂ , P ₂ O ₅ , MoO ₃ , WO ₃ , ThO ₂ , RbCl, NaBr, KBr, NaI, KI, MgCl ₂ , AlCl ₃



Note: Some substances chemically attack silica. In particular, hydrofluoric acid attacks it at all temperatures and phosphoric acid above 150 °C. Concentrated alkaline solutions may attack at high temperatures, while carbon and some metals may cause reduction.

10.7 Insulation Cracking

The insulation material in this furnace is susceptible to surface cracking as a result of temperature cycling. This is a normal occurrence and such cracking is not detrimental to the performance of the overall life of the furnace, under normal operation.

10.8 Pressure



Vessels are not intended to accept high internal pressure. When gas seals or similar fittings are in use, the gas pressure should be restricted to a **maximum of 0.07 bar (70 mbar)**. A pressure of approximately half of that should normally be sufficient to achieve the desired flow rate. The operator must ensure that the exhaust path from the vessel is not blocked, so that excess pressure does not occur.

- A suitably regulated gas supply should always be used.
- It is recommended that a pressure relief system should be used to avoid an over pressurisation of the vessel.

Note: A product should not be heated up if any valves that have been fitted are closed to create a sealed volume. A sealed vessel should not be heated from cold due to the pressure increase caused by the trapped air or gas expanding during the heating process.



Note: To minimise the increase of back pressure, always increase the pipe diameter of any room vent lines when connecting to a product exhaust outlet. For example, 6mm outlet connections should be increased to a diameter of 10mm or greater for room lines between 5 - 10 metres in length.



Note: Always maintain clean gas lines. Regularly inspect vent lines connected to the exhaust outlet as any build up of debris may increase the back pressure of the vessel.

11.0 Maintenance

11.1 General Maintenance

Preventive rather than reactive maintenance is recommended. The type and frequency depends on the product use; the following are recommended.









11.2 Maintenance Schedule

 CUSTOMER

 QUALIFIED PERSONNEL



DANGER! ELECTRIC SHOCK. Risk of fatal injury. Only electrically qualified personnel should attempt these maintenance procedures.

Maintenance Procedure	Method	Frequency				
		Daily	Weekly	Monthly	Bi-Annually	Annually
Safety						
Over-Temperature Safety Circuit (if fitted)	Set an over-temperature setpoint lower than the displayed temperature and check for an over-temperature alarm as detailed in this manual					
Over-Temperature Safety Circuit (if fitted)	Electrical measurement 					
Safety Switch Function	Set a temperature above ambient (no higher than 200°C), and open the furnace to see if the heater light goes out. The vessel should stop oscillating when the furnace is opened.					
Safety Switch Function	Electrical measurement 					
Electrical Safety (external)	Visual check of external cables and plugs					
Electrical Safety (internal)	Physically check all connections are tight, with no visible evidence of heat damage before proceeding with cleaning of the power plate area					
Electrical Safety (earthing)	Using a megohmmeter (insulation resistance tester), check the earth connection between the cable entry point and the main earth connection point, then between the main earth connection and the power plate, control box screw heads, top and bottom of the furnace body and vertical stand (if in use)					

Function						
Temperature Calibration	Tested using certified equipment, frequency dependent on the standard required					6
Operational Check	Check that all functions are working normally					
Operational Check	Thorough inspection and report incorporating a test of all functions					6
Vessel Position	Visually check that the vessel is central to the heated zone (horizontally / vertically)					
End Plugs / Radiation Shields	Visual check for damage or wear, and correct positioning					
Seals (if fitted)	Check all seals and O-rings and clamps					
Pneumatic struts	Ensure that the lid of the furnace is fully supported by the pneumatic struts when the furnace is opened					6
Drive System	Check that the drive system is sufficiently lubricated and free of debris/obstructions. The gears of the drive system should fully rotate when powered on					
Performance						
Element Circuit	Electrical measurement 					6
Power Consumption	Measure the current drawn on each phase / circuit					6

11.3 Cleaning



Note: Disconnect the product from the electrical supply before carrying out any maintenance procedures.

- With the product switched off, cold, and electrically isolated from the mains, wipe over surfaces using a damp cloth, wrung almost dry.
- **DO NOT** use solvents.
- If necessary, vacuum out the inside of the product to remove any dust or minor debris and dispose of any material removed, in accordance with local regulations, at an approved disposal facility.



Note: Care must be taken to ensure that no moisture enters the furnace or makes contact with any electrical components.

11.4 Safety Switch

When correctly functioning, the safety switch will isolate all live conductors (live and neutral connections) within the heating element circuit(s) when the product door is opened. The safety switch should be checked regularly to ensure that this occurs.

The safety switch should not fail under normal working conditions, however rough handling, exposure to corrosive materials/ environments, or exceptionally frequent use, could compromise the safety system.

Weekly check:

The following check can be carried out by a general operator:

- On the temperature controller, set a safe temperature above ambient. The heater lights should illuminate.
- Open the door and check the heater lights. They should no longer be illuminated.

If the heater lights remain illuminated when the door is open, discontinue use and contact Carbolite Gero Service.

Annual check:

The following checks should be carried out by a qualified electrician, as specified in the "Maintenance Schedule" section of this manual:

- Remove the element access panel and take a voltage measurement from the heating element terminals. Do not attempt to take a reading from the heating element

itself as surface oxidation will give an unreliable contact.

- Ensure that power to the heating elements is switched off when the door is opened.

Contact Carbolite Gero Service and discontinue use of the product if it is found that the heating elements are not fully isolated during these checks.

11.5 Calibration

After prolonged use, the controller and/or thermocouple may require recalibration. This is important for processes that require accurate temperature readings or for those that use the product close to its maximum temperature. A quick check using an independent thermocouple and temperature indicator should be made from time to time to determine whether full calibration is required. Carbolite Gero can supply these items.

Depending on the controller fitted, the controller instructions may contain calibration instructions.

11.6 After-Sales Service

Carbolite Gero Service has a team of Service Engineers who can offer repair, calibration and preventive maintenance of furnace and oven products both at the Carbolite Gero factory and at customers' premises throughout the world. A telephone call or email often enables a fault to be diagnosed and the necessary parts to be despatched.

In all correspondence please quote the serial number and model type given on the rating label of the product. The serial number and model type are also given on the back of this manual when supplied with the product.

Carbolite Gero Service and Carbolite Gero contact information can be found on the back page of this manual.

11.7 Recommended Spare Parts and Spare Parts Kit

Carbolite Gero can supply individual spare parts or a kit of the items most likely to be required. Ordering a kit in advance can save time in the event of a breakdown.

Please consult Carbolite Gero's Sales Department for details of recommended spare parts.

11.8 Maintenance Manual

Instructions for the repair and replacement of common components are detailed in the separate "Maintenance Manual" for this product. Please contact Carbolite Gero to request a copy.

12.0 Fault Analysis

Note: The heating lamps are located at the rear of the control box.

A. Furnace Does Not Heat Up					
1.	The heating lamps are ON	▶	The heating element has failed	▶	Check also that the SSR is working correctly
2.	The heating lamps are OFF	▶	The controller shows a very high temperature or code such as S.br (Sensorbreak)	▶	The thermocouple has broken or has a wiring fault
		▶	The controller shows a low temperature	▶	The door switch(es) (if fitted) may be faulty or need adjustment
				▶	The contactor/relay (if fitted) may be faulty
				▶	The SSR could be failing to switch on due to internal failure, faulty logic wiring from the controller, or faulty controller
		▶	There are no lights glowing on the controller	▶	Check the supply fuses and any fuses in the furnace control compartment
				▶	The controller may be faulty or not receiving a supply due to a faulty switch or a wiring fault.

B. Product Overheats					
1.	Product only heats up when the instrument switch is ON	▶	The controller shows a very high temperature	▶	The controller is faulty
		▶	The controller shows a low temperature	▶	The thermocouple may be faulty or may have been removed out of the heating chamber
				▶	The thermocouple may be connected the wrong way around
				▶	The controller may be faulty
2.	Product heats up when the instrument switch is OFF	▶	The SSR has failed "ON"	▶	Check for an accidental wiring fault that could have overloaded the SSR

13.0 Decommissioning, Storage and Disposal

13.1 Decommissioning

1. Reduce the setpoint on all temperature controllers to 0°C so that heating cannot begin accidentally when the product is recommissioned
2. Isolate the product from the power supply
3. Allow the product to cool to room temperature
4. Disconnect the product from the power supply
5. Disconnect all additional equipment and external connections e.g. gas supplies
6. Remove and store the work tube / vessel

13.2 Storage (Long Term)

Store in a cool, dry place.



Note: If the furnace is exposed to a humid environment during storage, it must be fully dried out before recommissioning. All internal electrical circuits should be checked for signs of moisture. If there are visible signs of moisture, the product should be isolated from the power supply and allowed to dry out at ambient temperature for at least 24 hours. Please contact Carbolite Gero Service for further advice.

13.3 Disposal



Note: This product should only be disposed of in accordance with local regulations and requirements regarding electrical equipment.

Within the European Community the disposal of electrically operated devices is regulated according to guidance based on the EU Directive 2012/19/EU on Waste Electrical and Electronic Equipment (WEEE). Disposal regulations may differ worldwide.

If uncertain, please contact Carbolite Gero for advice on disposal.

14.0 Declaration of Conformity

UK CA	Declaration of Conformity In accordance with BS EN ISO/IEC 17050-1:2010 Certificate No: 005	CE
------------------	--	-----------

Manufacturer's and Certificate Issue Address:	CARBOLITE GERO Ltd, Parsons Lane, Hope, Hope Valley, S33 6RB, England, UK. Tel: +44(0)1433 620011 info@carbolite-gero.com www.carbolite-gero.com
Product Range:	TSO1 / TSO3 - Oscillatory Reactor Furnaces
Models:	11/125/400, 11/125/600, 11/125/800, 11/125/1000
Carbolite Gero Ltd hereby declare that the products specified above comply with the essential safety requirements of the:	

Machinery Directive:	
2006/42/EC in accordance with:	
BS EN 746-1:1997+A1:2009	Thermoprocessing equipment. Common safety requirements for thermoprocessing equipment.
BS EN 746-3:2021	Industrial thermoprocessing equipment. Safety requirements for the generation and use of atmosphere gases
BS EN 60204-1:2018	Safety of Machinery. Electrical equipment of machines. General requirements.

EMC Directive:	
2014/30/EU in accordance with:	
BS EN 61326-1:2021	Electrical equipment for measurement, control and laboratory use. EMC requirements. General requirements.

RoHS Directive:	
2011/65/EU including CDD (EU) 2015/863 on the restriction of the use of certain hazardous substances in electrical and electronic equipment in accordance with:	
BS EN IEC 63000:2018	Technical documentation for the assessment of electrical and electronic products with respect to the restriction of hazardous substances.

Signed for on behalf of Carbolite Gero Ltd.:		Richard Bilson Director of Operations
Date:	27/02/2023	

ProductLabel

The products covered in this manual are only a small part of the wide range of ovens, chamber furnaces and tube furnaces manufactured by Carbolite Gero for laboratory and industrial use. For further details of our standard or custom built products please contact us at the address below, or ask your nearest stockist.

For preventive maintenance, repair and calibration of all furnace and oven products, please contact:

Carbolite Gero Service

Telephone: + 44 (0) 1433 624242

Fax: +44 (0) 1433 624243

Email: ServiceUK@carbolite-gero.com

Carbolite Gero Ltd,

Parsons Lane, Hope, Hope Valley,
S33 6RB, England.

Telephone: + 44 (0) 1433 620011

Fax: + 44 (0) 1433 621198

Email: Info@carbolite-gero.com

www.carbolite-gero.com

CARBOLITE
GERO 30-3000°C

Copyright © 2023 Carbolite Gero Limited