

Installation and Operation Instructions

1000-1150°C Retort Chamber Furnace Model GPCMA 37 litres

GPCMA 37

Contents

This manual is for guidance on the use of the Carbolite Gero product specified on the front cover. This manual should be read thoroughly before unpacking and using the furnace or oven. The model details and serial number are shown on the back of this manual. Use the product for the purpose for which it is intended.

1.0	Introduction	5
1.1	Scope and Purpose	5
1.1.1	Responsibilities	5
1.2	Prerequisites to Use	7
2.0	Safety	8
2.1	Symbols and Warnings	8
2.2	Operator Safety	9
2.3	Risk Prevention and Mitigating Residual Risks	10
2.4	Safety Warning - Refractory Fibre Insulation	10
3.0	Product Overview	12
3.1	Product Rating Label	12
3.2	Part Identification	13
3.3	Dimensions	14
4.0	Specifications	16
5.0	Electrical Specifications	17
5.1	Fuses and Power Settings	17
5.2	Operating / Storage Environment	17
6.0	Options and Accessories	18
6.1	Retort Options	18
6.2	Electrical Door Interlock (if fitted)	20
6.3	Gas System Options	21
6.3.1	Semi-Automatic Gas System with Analogue Flowmeters - Nitrogen/ Argon	21
6.3.2	Semi-Automatic Gas System with Digital Flowmeters	21
6.3.3	Automatic Gas System with Gas Monitoring & Control with Mass Flow Controllers	21
6.4	Gas Flow Rates	22
6.5	Forced Cooling Option (if fitted)	22
6.6	Automatic Vacuum Option (if fitted)	23
7.0	Installation	24
7.1	Manual Handling	24

7.2	Unpacking	24
7.3	Siting and Setting Up	25
7.4	Gas Connections	27
7.5	Electrical Connections	28
7.5.1	1-Phase Connections	28
7.5.2	3-Phase Connections	29
7.6	Retort Thermocouple Installation	30
8.0	Temperature Controller	31
9.0	Commissioning	32
9.1	Pre-Commissioning	32
9.2	Commissioning - Initial Function Checks	33
10.0	Operation	34
10.1	Safe Operation	34
10.2	Door Operation	34
10.3	Basic Operating Cycle	35
10.4	Vacuum Operation and Process Gas Control (if fitted)	36
10.4.1	Programming Example - Vacuum Option with Analogue / Digital Flowmeters	36
10.4.2	Programming Example - Vacuum Option with Mass Flow Controllers	38
10.4.3	Programming Example - Gas-Only Option with Analogue / Digital Flowmeters	40
10.4.4	Programming Example - Gas-Only Option with Mass Flow Controllers	41
10.5	Use of Probes and Metal Sheathed Thermocouples	42
10.6	Atmospheres	42
10.7	Power Adjustment	42
10.8	Insulation Cracking	42
11.0	Maintenance	43
11.1	General Maintenance	43
11.2	Maintenance Schedule	43
11.3	Cleaning	45
11.4	Safety Switch	45
11.5	Calibration	46
11.6	After-Sales Service	46
11.7	Recommended Spare Parts and Spare Parts Kit	46
12.0	Fault Analysis	47
A.	Furnace Does Not Heat Up	47
B.	Product Overheats	48

13.0	Decommissioning, Storage and Disposal	49
13.1	Decommissioning	49
13.2	Storage (Long Term)	49
13.3	Disposal	49

1.0 Introduction

1.1 Scope and Purpose

This product is intended to be used within a laboratory or industrial environment for the processing or testing of materials at high temperatures under a modified atmosphere.

It is supplied with a pre-fitted metal A105 retort designed for use with typically inert gases, nominally Argon (Ar) or Nitrogen (N).

It must be installed, commissioned, and operated in accordance with the instructions contained within this manual, and only by trained personnel.

For maintenance assistance, please contact Carbolite Gero.

Note: Depending on customer specifications at the time of order, this product may incorporate bespoke design features that are not covered in this manual. Please refer to the supplementary product documentation pack and/or contact Carbolite Gero for additional assistance.



Note: If this product is used for any application other than its intended purpose, as stated by Carbolite Gero, the protection provided by this equipment may be impaired.

Note: Failure to comply with the instructions as stated within this manual will constitute misuse and subsequently void any warranty provided by Carbolite Gero.



This product is supplied with a documentation pack, including instruction manuals and supplementary technical information. Read all documentation before proceeding with the installation and operation of this product.

1.1.1 Responsibilities

The customer is responsible for conducting their own risk assessment and ensuring that any materials to be processed within the product are suitable to be safely heated to the required temperature, and that appropriate safety measures are taken when handling such materials:

- Any material that is combustible or liable to cause explosions or generate combustible gas must not be processed unless the product is supplied with specialist equipment designed to manage such reactions

- The customer must provide an adequate ventilation and fume extraction system to manage any fumes given off by materials during processing

The customer is responsible for providing and maintaining the connections for the electrical power supply, and inert gas supply. The furnace should not be operated until all required supplies are connected.

This product should not be modified or used for any purpose other than that for which it is intended.

1.2 Prerequisites to Use

Prior to the commissioning and use of this product, all personnel involved in its installation, operation and maintenance must be deemed competent and have:

- Read and understood the information contained within this manual
- Received the relevant training with regard to safety and operation of the product
- Been provided with the appropriate PPE (Personal Protective Equipment) required for the safe operation of this product

Note: The customer is responsible for ensuring that all of the above conditions are satisfied before the product is commissioned for use.



Note: Unless otherwise specified, the customer is responsible for the installation of this product and the safe connection of any additional equipment and gas or liquid supply lines.











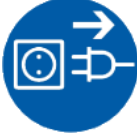











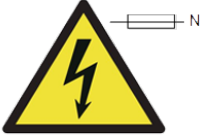

Note: Throughout this manual, written instructions are accompanied by diagrams. Diagrams may be highlighted in different colours and do not reflect the actual colouration of the product. Parts that are to be moved are highlighted in **YELLOW** and are intended to be fixed to, or removed from, surfaces highlighted in **BLUE**. Where applicable, arrows show the direction of movement.

2.0 Safety

2.1 Symbols and Warnings

Note: Observe and take the appropriate precautions if any of the following warning symbols are displayed on this product or in your working environment.

	Refer to the instruction manual before operating or maintaining the equipment		Disconnect the product from the power supply before performing any maintenance
	Wear eye protection		Wear a heat-resistant face shield
	Wear heat-resistant gloves		Wear breathing apparatus
	Wear protective footwear		Wear protective clothing
	Minimum of 2 people required to lift		DANGER: Heavy load. Specialist equipment required!
	WARNING!		DANGER: Risk of electric shock!
	DANGER: Fire risk!		DANGER: Hot surface!
	CAUTION: Double Pole/ Neutral Fusing!		DANGER: Risk of slipping!





	DANGER: Suspended loads!		WARNING: Adequate ventilation required!
	CAUTION: ROTATING EQUIPMENT		DANGER: Risk of crushing injury!
	DANGER: Explosive materials / atmosphere!		Any action noted beside this symbol is strictly forbidden!
	DO NOT use this product to cook or heat food or beverages!		DO NOT dispose! Recycle according to WEEE Regulation guidelines!

2.2 Operator Safety

Note: It is the responsibility of the customer to ensure that all personnel required to operate this product are fully trained and equipped with the appropriate PPE (Personal Protective Equipment).

Carbolite Gero recommend that the appropriate PPE is worn at all times whilst working with and around this product.

2.3 Risk Prevention and Mitigating Residual Risks

Risk		Prevention Measures
	Hot Surface	<ul style="list-style-type: none"> • Wear appropriate PPE e.g. heat resistant gloves • Do not place any objects on top of the product • Ensure the product is sited on a non-flammable surface, and that all adjacent surfaces are also non-flammable
	Ventilation required	<ul style="list-style-type: none"> • Only operate in a well ventilated area • If necessary, only operate in a fume cupboard
	Fire / Explosion	<ul style="list-style-type: none"> • Only trained operators should use this equipment • Only process materials for which a suitable risk assessment has been carried out
	Exposure to hazardous material	<ul style="list-style-type: none"> • Wear appropriate PPE e.g. protective gloves, dust masks, eye protection • Avoid breaking up insulation material • Please refer to section 2.4 for further details • If in doubt, please contact Carbolite Gero Service

2.4 Safety Warning - Refractory Fibre Insulation



Insulation made from High Temperature Insulation Wool Refractory Ceramic Fibre, better known as (Alumina silicate wool - ASW).

This product contains **alumino silicate wool** products in its thermal insulation. These materials may be in the form of blanket or felt, formed board or shapes, slab or loose fill wool.

Typical use does not result in any significant level of airborne dust from these materials, but much higher levels may be encountered during maintenance or repair.

Whilst there is no evidence of any long term health hazards, it is strongly recommended that safety precautions are taken whenever the materials are handled.

Exposure to fibre dust may cause respiratory disease.

When handling the material, always use approved respiratory protection equipment (RPE-eg. FFP3), eye protection, gloves and long sleeved clothing.

Avoid breaking up waste material. Dispose of waste in sealed containers.

After handling, rinse exposed skin with water before washing gently with soap (not detergent). Wash work clothing separately.

Before commencing any major repairs it is recommended to make reference to the European Association representing the High Temperature Insulation Wool industry (www.ecfia.eu).

Further information can be provided on request. Alternatively, Carbolite Gero Service can quote for any repairs to be carried out either on site or at the Carbolite Gero factory.

3.0 Product Overview

3.1 Product Rating Label

The product rating label is located on the side of the product control box.

Note: The image below is an example and does not reflect the product(s) covered by this manual.

UK CA	Carbolite GERO Ltd, Parsons Lane, Hope, Hope Valley, S33 6RB www.Carbolite – Gero.com		CE
	Country of Origin United Kingdom		
Type	TS 12/60/600	Manufactured	2020
	Serial No. 22-001028	Max Temp 1200°C	Power 2340 W
	Frequency 50-60 Hz	Volts 240 V	Phases 1
			Current 16.0 A

1	UKCA Mark
2	Carbolite Gero address and website
3	CE Mark
4	Country of Origin
5	Product Model
6	Year of Manufacture
7	Dispose of according to WEEE regulations (Waste Electrical and Electronic Equipment Directive)
8	Product Serial Number
9	Maximum Temperature
10	Power Rating
11	Frequency (Hertz)
12	Design Voltage
13	Design Phases
14	Current (Amps)

3.2 Part Identification

Note: Some models may have additional options and features that are not represented by the following images.

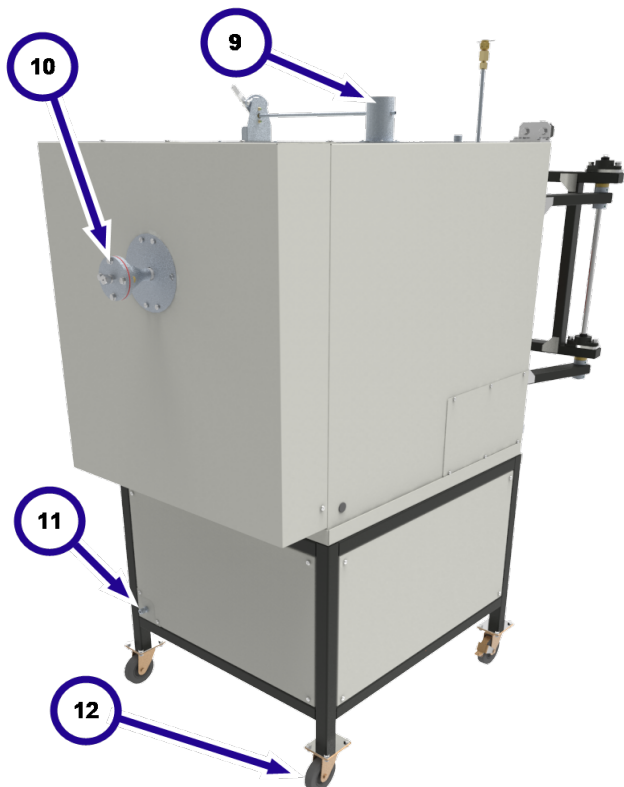
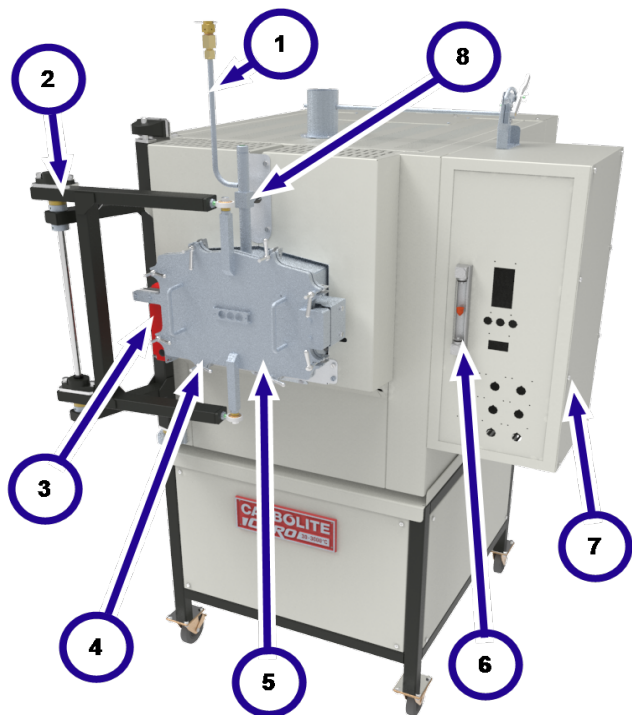

1	Retort pressure relief valve
2	Door gear assembly
3	Electrical door interlock
4	Retort securing nuts
5	Retort door
6	Flowmeter (Digital/Analogue/Mass Flow)
7	Control Panel
8	Oxygen Sensor (Lambda Sensor)
9	Chimney
10	Thermocouple glands
11	Gas supply inlet port
12	Castors

3.3 Dimensions

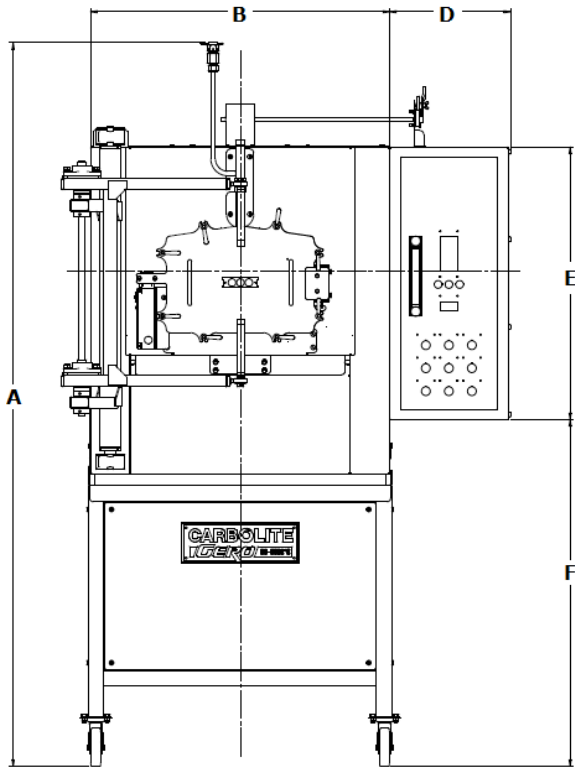

A	Height of furnace
B	Width of furnace
C	Depth of furnace
D	Width of control panel
E	Height of control panel
F	Clearance below control panel
G	Width of unit (door closed)
H	Width of unit (maximum with door open)
I	Depth of unit (from pivot point to furnace back panel)
J	Height from floor to base of retort
K	Depth of retort (internal)
L	Maximum height of retort (internal)
M	Height of retort side (internal)
N	Width of retort (internal)
O	Maximum radius of door from pivot point

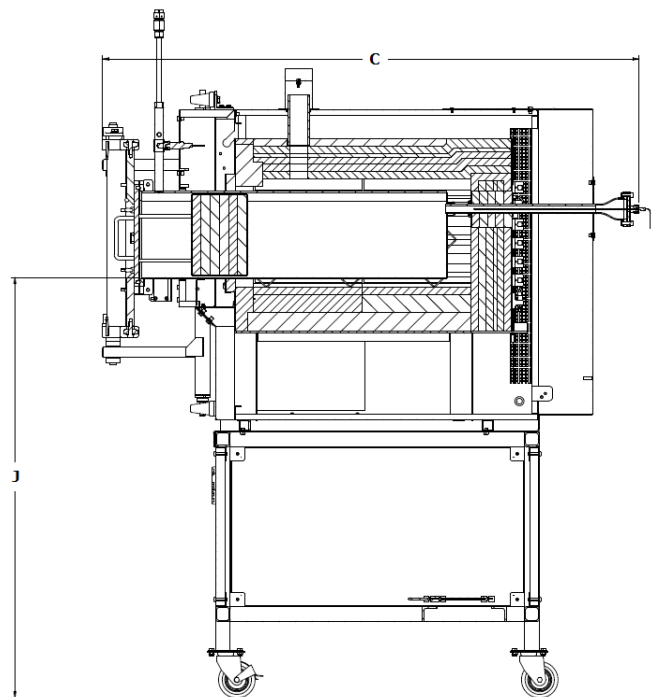
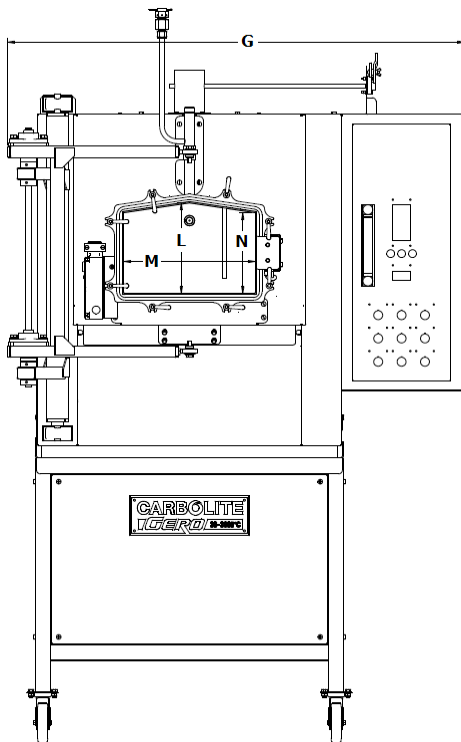

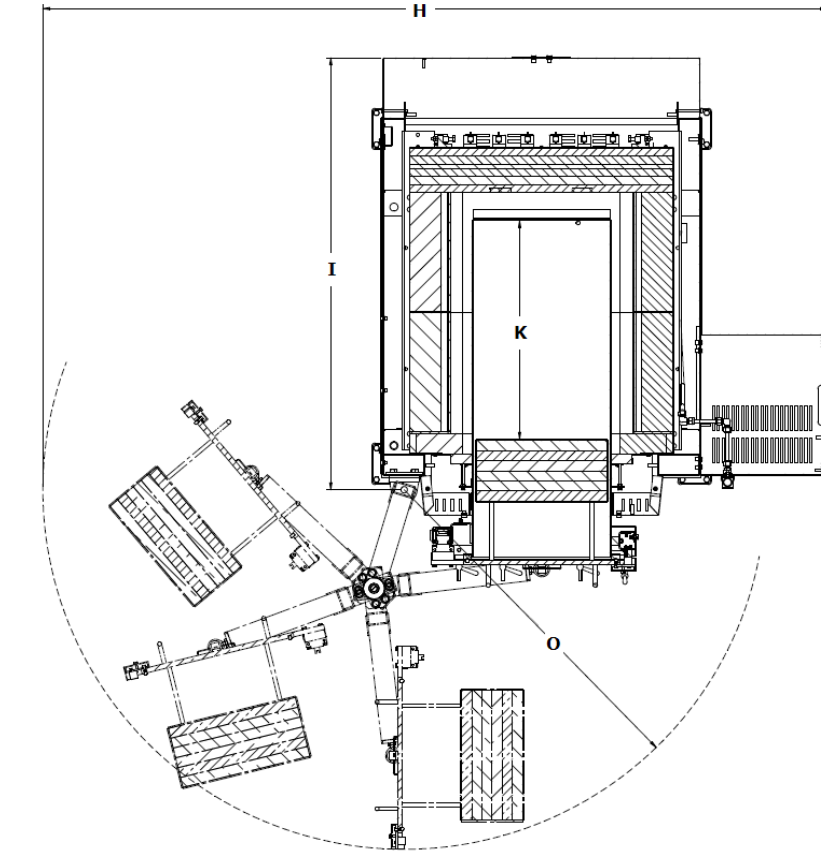

Note: All dimensions are measured in millimetres (mm).

A	B	C	D*	E*	F	G	H	I	J	K	L	M	N	O
1890	780	1469	316	711	906	1173	1944	1068	1156	542	233.4	208	337	902

* These dimensions may change depending on the controller options ordered. Please refer to the separate product documentation pack for details relevant to your furnace.

4.0 Specifications

Furnace		Retort Material
Maximum Temperature (°C)	1000	310 Stainless Steel
	1050	314 Stainless Steel
	1100	Inconel 601
	1150	Haynes 230
Maximum Continuous Operating Temperature (°C)	900	310 Stainless Steel
	950	314 Stainless Steel
	1000	Inconel 601
	1050	Haynes 230



Note: Please refer to the separate product documentation pack for additional specifications relevant to your product.

5.0 Electrical Specifications



This equipment MUST be earthed!

5.1 Fuses and Power Settings

Please refer to the supplementary electrical information in the product document pack provided with this product.

5.2 Operating / Storage Environment

The products covered by this manual contain electrical parts and should be stored and used in indoor conditions as follows:

Temperature:	5°C - 40°C
Relative humidity:	Maximum 80% up to 31°C decreasing linearly to 50% at 40°C
Altitude:	Not exceeding 2000 metres

6.0 Options and Accessories

Note: Any additional equipment to be used with this product should be supplied by Carbolite Gero. Accessories from third-party sources are not designed to Carbolite Gero's specifications and may result in poor performance, damage to equipment or dangerous working conditions.

6.1 Retort Options



Note: Before connecting the product to the electrical supply, the retort **MUST** be earthed! This product contains ceramic insulation materials that can become conductive at high temperature. Also, in furnaces with exposed heating elements, there is a danger of a metal retort directly coming into contact with the elements. Precautions must therefore be taken to avoid electric shock.

The GPCMA is available with a range of retort materials with different properties, as follows:

Retort Material	Maximum Operating Temperature
310 Stainless Steel	1000°C
314 Stainless Steel	1050°C
Inconel 601	1100°C
Haynes 230	1150°C

Note: When a furnace is ordered with the vacuum option, a specially designed vacuum retort is required. These are available in the same materials as described above. The vacuum system must only be operated when the furnace is at room temperature. Any attempt to use the vacuum system during heating will cause damage to the retort.



Note: Because the exact details of the customer's process are unknown, it is not possible to account for process-specific wear to the retort material. The working life of the retort is variable and depends entirely on the operating temperatures, program ramp rates, and properties of the materials being heated. Subsequently the retort is classed as a consumable item and is not covered by the standard Carbolite Gero warranty terms.



Note: Retorts are designed for use with **inert gas only**. The use of reactive gases will cause damage to the retort and endanger the operator.

6.2 Electrical Door Interlock (if fitted)

Note: To open the door, the electrical supply to the product must be switched on!

The electrical door interlock is situated on the left-hand side of the retort door. It is linked to a relay within the main temperature controller and can be configured to operate based on a temperature limit.

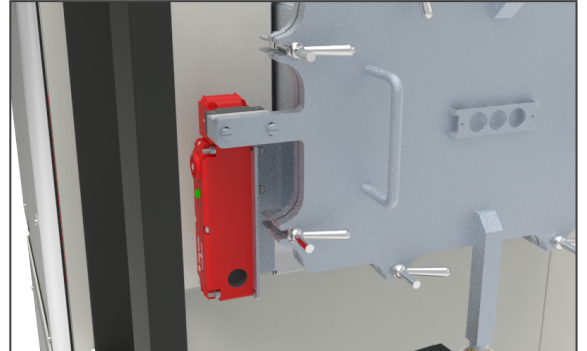

Note: If a gas system is fitted, the electrical door interlock will also activate if the gas is flowing.

The door interlock is activated when the temperature of the product is above a pre-set level, usually 80°C.

When the product is above the pre-set temperature, the indicator lamp will illuminate and the operator will be unable to open the door.

The door lock will automatically deactivate when the product drops below the pre-set temperature level.

6.3 Gas System Options

This product is available with a choice of gas system and flowmeter options. The flow of gas is always turned on and off by program segment events within the temperature controller/ programmer, regardless of gas system option.

6.3.1 Semi-Automatic Gas System with Analogue Flowmeters - Nitrogen/ Argon

Gas flow rates are required to be set manually via needle valves, but gas flow is turned on automatically by the temperature controller/ programmer via program segment events.

All analogue flowmeter options use tapered flow tubes and floats as a visual indicator of flow rates. Gas flow data cannot be recorded or stored when using analogue flowmeters.

6.3.2 Semi-Automatic Gas System with Digital Flowmeters

Digital flowmeters read the gas flow rate electronically, but do not control the flow; gas flow rates are set manually via needle valves.

Data can be read on the front panel display, and is also transmitted to the temperature programmer, and then onto a digital recorder (if fitted), for remote reading and recording.

Should the process gas require to be changed, e.g. from nitrogen to argon, digital flowmeters provide the additional benefit of enabling the operator to change the type of gas for which the instrument is calibrated, simply by adjusting the settings on the front panel controls.

6.3.3 Automatic Gas System with Gas Monitoring & Control with Mass Flow Controllers

The mass flow controllers receive their target flow rates electronically from the temperature programmer, and then control the gas flows accordingly. The flow rates measured by the mass flow controllers are also transmitted back to the programmer, and then onto a digital recorder (if fitted), for remote reading and recording.

6.4 Gas Flow Rates

The GPCMA gas system includes two gas flow rates, purge (high) and process (low):

- The purge flow rate is used initially to reduce oxygen levels within the retort chamber and create an inert gas atmosphere.
- The process flow rate is used during heating to maintain the atmosphere within the retort chamber.

Specific gas flow rates will vary depending on the application, however typical flow rates are as follows:

- **Purge** - 20-50 litres per minute
- **Process** - 3-15 litres per minute

Note: The flow rates can be adjusted to suit your process. If the material being processed produces fumes (offgassing) then a higher process flow rate may be required to compensate.

Note: The gas flow rates must be set in the furnace controller for each segment within the program. Please refer to the separate controller manual for details on how to edit program segments.

6.5 Forced Cooling Option (if fitted)

The forced cooling system blows room temperature air around the outside of the retort, enabling the retort to cool quickly whilst maintaining an inert atmosphere. Its operation is entirely controlled via program segment events within the temperature controller/ programmer.

Two actuated damper valves, one mounted within the furnace case towards the rear, and one connected to the chimney, reduce natural air flow around the retort when the forced cooling fan is not in operation.

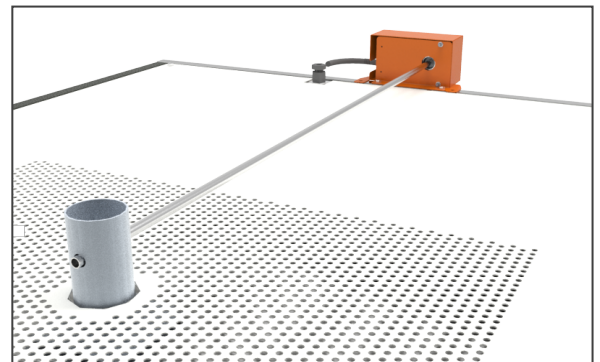

This option can reduce furnace cool-down times by almost 50%, and is ideal for processes that require rapid cooling of work pieces, whilst providing the potential for increased throughput.

6.6 Automatic Vacuum Option (if fitted)

The purpose of the (cold) vacuum system is to reach low oxygen levels within the furnace retort as quickly as possible. This is achieved by pulling a rough vacuum in the retort, then backfilling (purging) it with inert gas or nitrogen to displace the remaining oxygen. This process can be repeated as required before turning off the vacuum system and swapping to a process gas flow at ambient pressure.

For more information on gas flows, please refer to the section 6.4.

Applying a vacuum also has the added benefit of removing trapped gas from porous work pieces, although this is not the primary purpose of the system.



Note: The vacuum system should only be operated when the furnace is at room temperature (cold). Operating the vacuum system during heating will cause damage to the furnace retort.

Note: For assembly and connection details, please refer to the separate vacuum pump manual in the supplementary product documentation pack.

7.0 Installation

7.1 Manual Handling



Refer to section 3.2 of this manual for product dimensions.



Mechanical lifting equipment may be necessary!

Consult personnel responsible for health and safety before attempting to move this product!

It is the responsibility of the customer to provide any mechanical lifting aids, such as pallet trucks, forklifts or cranes, and to ensure that all operators of such equipment are fully trained and qualified.



All manual handling must be carried out according to local health and safety guidelines.

Note: The customer is responsible for all manual handling procedures performed on their own premises.

7.2 Unpacking

Note: Check that all items intended for delivery are present and undamaged before proceeding to install the product.

Note: The GPCMA/37 is fitted with castors, allowing it to be easily wheeled into the desired position.

For safety and manoeuvrability, the product is delivered secured to a pallet inside a crate.

It is advised that the product is left on the pallet until it has been moved as close as possible to its intended installation location.

- Using the appropriate tools, carefully open the crate and remove all external packaging. Retain the crate panels and packaging.
- Ensuring that the product is stable and secure, remove any straps retaining the product to the pallet.
- If using a crane, attach appropriate straps or hooks to the four lifting eyes on the top of the furnace and ensure they are secure before proceeding.
- Manoeuvre the furnace into the desired position, ensuring that there is sufficient

- clearance above and around the sides of the furnace body.
- Remove the straps/hooks from the lifting eyes.

7.3 Siting and Setting Up



The product should be sited in a well ventilated area, away from other sources of heat.

Note: If required, it is the customer's responsibility to provide an adequate extraction system. Under no circumstances should such an extraction system be connected directly to the product as this will affect product performance and may damage equipment.



Use the manual handling method recommended by your health and safety officer to place the product on a level, stable surface that is not prone to vibration or movement. The surface upon which the product is placed must be of a height suitable to allow the operator to easily and safely use the equipment.



The product should be placed on a non-flammable surface, resistant to the accidental spillage of hot materials. All adjacent surfaces should also be non-flammable.



Ensure that the power supply or isolating switch is easily accessible to the operator.

The surface on which the equipment is mounted should be stable and not subject to movement or vibrations.

The height of the mounting surface is important to avoid operator strain when loading and unloading samples. An optional custom loading trolley is available. Please contact Carbolite Gero for details.

Unless otherwise stated elsewhere in this manual, ensure that there is **at least 1000 mm** of free space around the back and **at least 500mm** of free space at the sides of the product. Clear space is required above the product to dissipate heat.



* **Note:** Please refer to section 3.2. Adequate space must be provided to accommodate the furnace with the door open.



Note: Depending on the application of the product, it may be appropriate to position it under an extraction hood. Ensure the extraction hood is switched on during use. It is recommended that an extraction system capable of a **minimum of 1359 cubic metres per hour (800 CFM)** is used.



Under no circumstances should any objects be placed on top of the product. Always ensure that any vents on the top of the product are clear of any obstruction. Always ensure all cooling vents and cooling fans (if fitted) are clear of any obstruction.

7.4 Gas Connections



Note: The furnace retort is not designed to operate as a pressure vessel, and is fitted with a pressure relief valve at the exhaust. To mitigate the risk of pressure build up, before each use, check that the retort exhaust pipe is free of any obstructions e.g. condensed tar.

- The main gas supply inlet is situated at the rear of the furnace.
- The gas supply line to the retort is fitted and contained within the main furnace body and does not require assembly.
- All connections are secured with 10mm compression fittings.



7.5 Electrical Connections



For products supplied without pre-fitted plugs, it is recommended that all electrical connections are carried out by a qualified electrician.

The product covered by this manual normally requires a single phase A.C. supply, which may be "Live to Neutral non-reversible", "Live to Neutral reversible" or "Live to Live". Some models may be ordered for 3-phase use, which may be with or without neutral.

Check the product rating label before connection. The supply voltage should correspond with the voltage on the label and the supply capacity should be sufficient for the current on the label.

The supply should be fused at the next size equal to, or higher than the current on the label. This manual contains a table of the most common fuse ratings.

- When the mains cable is factory-fitted / supplied, internal fuses are also fitted. It is essential that the operator ensures that the power supply is correctly fused.
- Products with a factory fitted supply cable but without a plug are designed to be wired directly to an isolator or fitted with a line plug compliant with the customer's local regulations and supply.
- Products without a factory-fitted supply cable require a permanent connection to a fused and isolated supply. The product's electrical component access panel should be temporarily removed, and connections made to the internal terminals / fuse holder.

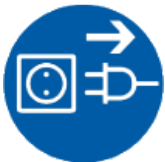

When connecting the product to the power supply, the plug or isolating switch should be accessible, easy to remove / operate, and within reach of the operator.

Note: The supply MUST incorporate an earth (ground).

7.5.1 1-Phase Connections

Terminal Label	Cable Colour	Supply Type & Connection	
		<i>Live - Neutral</i>	<i>Reversible or Live - Live</i>
L1	Brown	to live	to either power conductor (for USA 200-240 V, connect L1)
N / L2	Blue	to neutral	to the other power conductor (for USA 200-240 V, connect L2)
PE	Green / Yellow	to earth (ground)	to earth (ground)

7.5.2 3-Phase Connections

Terminal Label	Cable Colour	Connection
L1	Black	to phase 1
L2	Black	to phase 2
L3	Black	to phase 3
N	Light Blue	to neutral (if fitted)
PE	Green / Yellow	to earth (ground)

7.6 Retort Thermocouple Installation

Probe thermocouples enable operators to record more accurate temperature readings inside a heated vessel (work tube, retort, reactor etc.).

The thermocouples enter the retort through compression glands, and plug into the corresponding sockets on the furnace case.

Thermocouples may also be plugged into an independent external temperature reader.

To install the retort thermocouples:

Note: Ensure that there is sufficient space at the rear of the furnace to allow for the easy insertion and withdrawal of thermocouples.

- Gently twist the compression nut on the thermocouple gland to loosen the seal and allow for thermocouple access.
- Carefully insert the probe thermocouple through the gland.
- Securely tighten the gland to ensure that the thermocouple remains in position and that any atmosphere contained inside the retort does not escape.

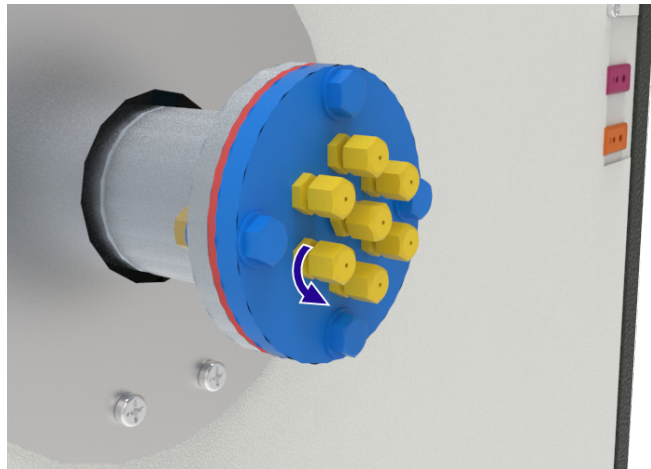

- Connect the male end of the thermocouple lead to the relevant socket at the rear of the furnace body. The socket(s) are labelled.

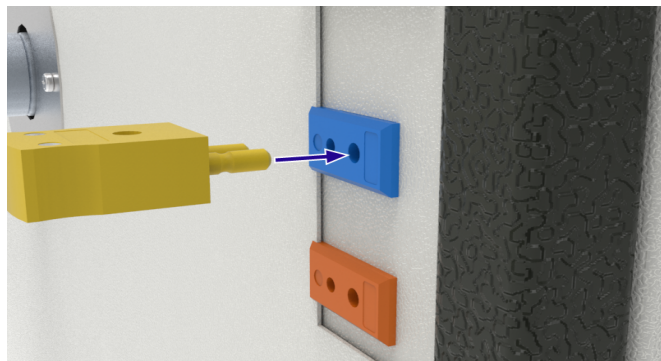

8.0 Temperature Controller

Please refer to the separate temperature controller manual(s) provided.

9.0 Commissioning

Note: This equipment should not be put into use until it has been commissioned by a competent person in accordance with the instructions contained within this manual, and any local regulations. Carbolite Gero offer an installation and commissioning service. Please contact Carbolite Gero Service for details.

9.1 Pre-Commissioning

When the product is cold and disconnected from the power supply, visually check the following:		Checked by:
Siting / Securing	Check that the product is placed on a secure, level surface and cannot topple over.	
Packaging	Check that all packaging material has been removed from inside and around the product.	
General Condition	Check that no damage has occurred during delivery and siting.	
Electrical Door Interlock	Check that the retort door cannot be opened when there is no power to the furnace.	
Panels	Check that all covers and access panels are securely fitted.	
General Access	Check that there is sufficient clearance around the top and all sides of the product (refer to section 7.3).	
Ventilation	Check that the product has been installed in a well ventilated area.	
Extraction	If a room extraction system is in operation (not supplied by Carbolite Gero), check that there is sufficient clearance between the extraction hood and the product.	
Gas Supply	Check that the gas supplies (not supplied by Carbolite Gero) are correct and appropriate for the equipment.	
Electrical Supply	<ul style="list-style-type: none"> • Check that the voltage stated on the product rating label matches the electrical supply of the installation site. • Check that all electrical supply cables are securely attached to/ plugged into the product. 	
Earth Connection	Check that an earth connection has been made. The retort and all removable panels should be earthed.	
Gas Connections	Check that all connections between the equipment	

	<p>have been made as detailed in this manual:</p> <ul style="list-style-type: none"> • Gas supply to furnace • Gas supply to retort 	
Thermocouples	Check that the required thermocouples are inserted through the glands at the rear of the furnace.	
Rating Label / Warning Labels	Check that all labels are fitted and all information is legible.	

9.2 Commissioning - Initial Function Checks

When the product has been connected to the mains electrical supply, check the following:		Checked by:
Power Switch	Check that when turned to the ON position, the instrumentation on the control panel illuminates.	
Gas Connections	<ul style="list-style-type: none"> • Check that all the connections to the gas supply are secure and that gas flows correctly through the system e.g. flowmeters register, solenoid valves open. • Set the desired gas flow rates. 	
Electrical Door Interlock	<ul style="list-style-type: none"> • Check that the retort door can be opened when power is supplied to the furnace. • Check that the retort door cannot be opened when it should remain locked. This depends on the option ordered (see section 6.2). 	
Electrical Access Panel	Check that the access panel doors are locked to prevent unauthorised access/gas flow adjustments.	

10.0 Operation

10.1 Safe Operation



This product can be operated continuously up to **100°C below** the maximum operating temperature, however constant use at high temperatures can accelerate the degradation process of various components which will require replacement. Please contact Carbolite Gero to request the "Maintenance" manual for your product.



Note: DO NOT leave the product operating unattended unless the over-temperature protection option is fitted.



Refer to the "Safety" section of this manual for details on ensuring operator safety.

Explosive materials:



- The furnace must not be used to heat materials that could explode, or that could emit gases that could form explosive mixtures. If the safe heating of a material is dependent on its temperature, only heat these types of materials if the furnace has the optional over-temperature protection device fitted.
- Ensure that the over-temperature device is calibrated and set to an over-temperature safety limit that is appropriate for the material being heated so as to avoid any hazards. If in doubt, seek expert advice before proceeding.
- Customers are responsible for carrying out their own risk assessments on the heating of materials.

Switch off the furnace before loading and unloading:



- The furnace elements must be switched off using the instrument switch when the furnace is being loaded or unloaded.
- Ceramic materials can become electrically conductive at high temperatures.
- If an element has failed and collapsed onto the retort, the retort will become live which could cause serious injury or death.

10.2 Door Operation

The furnace door operates on a double-pivot hinge system, enabling the operator to open the furnace whilst remaining shielded from any radiant heat.

The door is secured using 8 manual screw bolts, and features an electrical interlock which prevents the door from being opened while the furnace is in operation.

To access the furnace chamber:

- Unscrew the door bolts and flip them back away from the door.
- Whilst holding both front handles, gently pull the door directly outwards, taking care to avoid the door plug making contact with the inside of the retort chamber.
- Using the double pivot system, carefully guide the door out and away from the furnace and move it horizontally across to the side, at all times ensuring the hot face is directed away from the operator(s).

Note: Do not allow the door to swing freely as this could result in operator injury or damage to the furnace door plug.

10.3 Basic Operating Cycle

This product is fitted with a mains isolation switch which cuts off power to the control circuit.

1. Connect the product to the electrical supply
2. Turn on the mains isolation switch on the lower left hand side of the furnace case.
3. Turn on the instrument switch to activate the temperature controllers. The controllers illuminate and go through a short test cycle
4. **Over-Temperature option only:** If the digital over-temperature option has not yet been set as required, set and activate it according to the over-temperature controller instructions.
5. If a setpoint has been set on the main temperature controller, the product will start to heat up. The heating lamp(s) will glow steadily at first and then flash as the product approaches the desired temperature or a program setpoint.
6. **Over-Temperature option only:** If the over-temperature circuit has tripped, an indicator on the over-temperature controller flashes and the heating elements are isolated. Find and correct the cause before resetting the over-temperature controller according to the instructions supplied.
7. To switch off power to the heating elements, reduce the setpoint value to 0°C.
8. To switch the product off, turn off the instrument switch, then turn off the mains isolation switch.

Note: If the product is to be left switched off and unattended, isolate it from the electrical supply.

10.4 Vacuum Operation and Process Gas Control (if fitted)

Both the vacuum (if fitted) and gas systems are controlled by the temperature controller/ programmer. Vacuum and process gas injections can only be operated via program segment events within a temperature program.

Automatic valves control the exhaust gas flow, sending it either via the vacuum pump or directly to the exhaust chimney.



Note: The vacuum pump cannot be operated when the furnace is above 50°C.

In a running temperature program, when the vacuum pump is enabled and the furnace is <50°C, the exhaust valve will close and the vacuum valve will open.

When the vacuum pump is turned off and the gas flow turned on, the vacuum valve will close and the exhaust valve will remain closed until the retort relative pressure reaches approximately +10mbar, in order to prevent air being sucked back into the retort.

Process gas is controlled by two solenoid valves (low and high flow rates).

In models with manual or semi-automatic gas system options, the flow rates are set manually using needle valves. These valves are located in the furnace base behind the access panel on the lower right-hand side; this prevents any inadvertent or unauthorised adjustment of gas flow rates.



Note: In models with a fully automatic gas system, the flow rates are set digitally via the temperature program

10.4.1 Programming Example - Vacuum Option with Analogue / Digital Flowmeters

In order for the vacuum and gas systems to work correctly and safely, it is necessary for temperature programs to follow a specific format.



Note: The following program is for example purposes only. Please refer to the separate product documentation pack for programming instructions relevant to your product.

In each program segment within the temperature controller/ programmer, there are four "Events" that may be activated:

- Event 1 starts the vacuum pump
- Event 2 turns on the purge (high) gas flow rate (flow rate 1)
- Event 3 controls the process (low) gas flow rate (flow rate 2)
- Event 4 starts the forced cooling system (if fitted)

Note: Event 1 cannot be active when either Event 2 and/ or Event 3 are active.

Note: If an event is not set to be ON, it will be OFF (inactive) by default.

The vacuum level is user adjustable, but is preset to -0.95 relative (-950mbar below atmospheric) - see step 3 in the following programming example.

This example is based on a model with optional vacuum and forced cooling systems, and may be edited and adapted as required:

1	STEP to 0°C, Event 1 ON	<ul style="list-style-type: none"> • Furnace cold • Start the vacuum pump
2	DWELL for 10 minutes, Event 1 ON	<ul style="list-style-type: none"> • Pump down for a minimum of 10 minutes
3	WAIT for PrgIn1 and/or PrgIn2	<ul style="list-style-type: none"> • Wait until retort pressure is below -950mbar AND/OR • Wait until O₂ level is below 0.005%
4	DWELL for 10 minutes, Event 2 ON	<ul style="list-style-type: none"> • Vacuum pump off • High gas flow rate for 10 minutes • The exhaust opens when the retort pressure reaches +10mbar • Steps 1-4 may be repeated for multiple vacuum/ gas backfill cycles
5	RAMP to 1050°C @ 5°C/min, Event 3 ON	<ul style="list-style-type: none"> • Heat to 1050°C • Low gas flow rate
6	DWELL for 60 minutes, Event 3 ON	<ul style="list-style-type: none"> • Dwell at 1050°C • Low gas flow rate
7	RAMP to 90°C @ 5°C/min, Event 3 and Event 4 ON	<ul style="list-style-type: none"> • Forced cool down to 90°C • Low gas flow rate
8	STEP to 0°C, Event 3 ON	<ul style="list-style-type: none"> • Shut the furnace down • Low gas flow rate • Turn off the forced cooling system
9	DWELL for 10 minutes, Event 2 ON	<ul style="list-style-type: none"> • Purge with a low gas flow rate for 10 minutes
10	END, all Events OFF	<ul style="list-style-type: none"> • Shut down all gas flows

		<ul style="list-style-type: none"> • Natural cooling • Open the chimney
--	--	---

10.4.2 Programming Example - Vacuum Option with Mass Flow Controllers

In order for the vacuum and gas systems to work correctly and safely, it is necessary for temperature programs to follow a specific format.



Note: The following program is for example purposes only. Please refer to the separate product documentation pack for programming instructions relevant to your product.

In each program segment within the temperature controller/ programmer, there are three "Events" that may be activated:

- Event 1 starts the vacuum pump
- Event 2 enables the gas flow
- Event 3 starts the forced cooling system (if fitted)

Note: Event 1 cannot be active when either Event 2 and/ or Event 3 are active.

Note: If an event is not set to be ON, it will be OFF (inactive) by default.

The vacuum level is user adjustable, but is preset to -0.95 relative (-950mbar below atmospheric) - see step 3 in the following programming example.

This example is based on a model with optional vacuum and forced cooling systems, and may be edited and adapted as required:

1	STEP to 0°C, Event 1 ON	<ul style="list-style-type: none"> • Furnace cold • Start the vacuum pump
2	DWELL for 10 minutes, Event 1 ON	<ul style="list-style-type: none"> • Pump down for a minimum of 10 minutes
3	WAIT for PrgIn1 and/or PrgIn2	<ul style="list-style-type: none"> • Wait until retort pressure is below -950mbar AND/OR • Wait until O₂ level is below 0.005%
4	DWELL for 10 minutes, Event 2 ON	<ul style="list-style-type: none"> • Vacuum pump off • Gas flow for 10 minutes • The exhaust opens when the retort pressure reaches +10mbar • Steps 1-4 may be repeated for multiple vacuum/ gas backfill cycles

5	RAMP to 1050°C @ 5°C/min, Event 2 ON	<ul style="list-style-type: none">• Heat to 1050°C• Gas flow on
6	DWELL for 60 minutes, Event 2 ON	<ul style="list-style-type: none">• Dwell at 1050°C• Gas flow on
7	RAMP to 90°C @ 5°C/min, Event 2 and Event 3 ON	<ul style="list-style-type: none">• Forced cool down to 90°C• Gas flow on
8	STEP to 0°C, Event 2 ON	<ul style="list-style-type: none">• Shut the furnace down• Gas flow on• Turn off the forced cooling system
9	DWELL for 10 minutes, Event 2 ON	<ul style="list-style-type: none">• Purge with gas for 10 minutes
10	END, all Events OFF	<ul style="list-style-type: none">• Shut down all gas flows• Natural cooling• Open the chimney

10.4.3 Programming Example - Gas-Only Option with Analogue / Digital Flowmeters

In order for the gas system to work correctly and safely, it is necessary for temperature programs to follow a specific format.



Note: The following program is for example purposes only. Please refer to the separate product documentation pack for programming instructions relevant to your product.

In each program segment within the temperature controller/ programmer, there are three "Events" that may be activated:

- Event 1 starts the high gas flow rate
- Event 2 enables the low gas flow rate
- Event 3 starts the forced cooling system (if fitted)

Note: If an event is not set to be ON, it will be OFF (inactive) by default.

This example is based on a model with the optional forced cooling system, and may be edited and adapted as required:

1	STEP to 0°C, Event 1 ON	<ul style="list-style-type: none"> • Furnace cold • High gas flow rate
2	WAIT for PrgIn1	<ul style="list-style-type: none"> • Wait until O₂ level is below 0.005%
3	RAMP to 1050°C @ 5°C/min, Event 1 ON	<ul style="list-style-type: none"> • Heat to 1050°C • Low gas flow rate
4	DWELL for 60 minutes, Event 2 ON	<ul style="list-style-type: none"> • Dwell at 1050°C • Low gas flow rate
5	RAMP to 90°C @ 5°C/min, Event 2 and Event 3 ON	<ul style="list-style-type: none"> • Forced cool down to 90°C • Low gas flow rate
6	STEP to 0°C, Event 2 ON	<ul style="list-style-type: none"> • Shut the furnace down • Low gas flow rate • Turn off the forced cooling system
7	DWELL for 10 minutes, Event 2 ON	<ul style="list-style-type: none"> • Purge with a low gas flow rate for 10 minutes
8	END, all Events OFF	<ul style="list-style-type: none"> • Shut down all gas flows • Natural cooling • Open the chimney

10.4.4 Programming Example - Gas-Only Option with Mass Flow Controllers

In order for the gas system to work correctly and safely, it is necessary for temperature programs to follow a specific format.



Note: The following program is for example purposes only. Please refer to the separate product documentation pack for programming instructions relevant to your product.

In each program segment within the temperature controller/ programmer, there are two "Events" that may be activated:

- Event 1 starts the gas flow
- Event 2 starts the forced cooling system (if fitted)

Note: If an event is not set to be ON, it will be OFF (inactive) by default.

Note: The gas flow rates must be set in the furnace controller for each segment within the program. Please refer to the separate controller manual for details on how to edit program segments.

This example is based on a model with the optional forced cooling system, and may be edited and adapted as required:

1	STEP to 0°C, Event 1 ON	<ul style="list-style-type: none"> • Furnace cold • Gas flow on
2	WAIT for PrgIn1	<ul style="list-style-type: none"> • Wait until O₂ level is below 0.005%
3	RAMP to 1050°C @ 5°C/min, Event 1 ON	<ul style="list-style-type: none"> • Heat to 1050°C • Gas flow on
4	DWELL for 60 minutes, Event 1 ON	<ul style="list-style-type: none"> • Dwell at 1050°C • Gas flow on
5	RAMP to 90°C @ 5°C/min, Event 1 and Event 2 ON	<ul style="list-style-type: none"> • Forced cool down to 90°C • Gas flow on
6	STEP to 0°C, Event 1 ON	<ul style="list-style-type: none"> • Shut the furnace down • Gas flow on • Turn off the forced cooling system
7	DWELL for 10 minutes, Event 1 ON	<ul style="list-style-type: none"> • Purge with a gas flow for 10 minutes
8	END, all Events OFF	<ul style="list-style-type: none"> • Shut down all gas flows • Natural cooling

- Open the chimney

10.5 Use of Probes and Metal Sheathed Thermocouples



Any metal object used to probe into the product chamber while the product is connected to the electrical supply must be earthed. This applies in particular to metal sheathed thermocouples, where the sheaths must be earthed. The refractory material of the chamber lining becomes partly conductive at high temperatures and the electric potential inside the chamber can be at any value between zero and the supply voltage. Unearthed probes can cause serious electric shock.

10.6 Atmospheres

This product is designed to be used ONLY with inert gases e.g. argon, or nitrogen. In practice, inert or oxidising gases may be used.



WARNING:DO NOT use combustible or toxic gases within this product.

10.7 Power Adjustment

The product control system incorporates electronic power limiting. Depending on the model and the destination country the power limit maybe set to 100% or a lower figure. Where appropriate the power limit parameter OP.Hi is accessible to the operator, but it should not generally be altered.

See section 5.0 for details of the power limit settings. DO NOT adjust the power to a level higher than the design level states; this may cause a fuse to blow and could damage the heating elements.

The power limit may be set to a lower limit if the product is to be used at a low temperature only: this may give better control stability. It may be set to zero to permit demonstration of the controls without the heating elements taking power; to resume heating reset it to its standard value.

10.8 Insulation Cracking

The insulation material in this furnace is susceptible to surface cracking as a result of temperature cycling. This is a normal occurrence and such cracking is not detrimental to the performance of the overall life of the furnace, under normal operation.

11.0 Maintenance

11.1 General Maintenance

Preventive rather than reactive maintenance is recommended. The type and frequency depends on the product use; the following are recommended.













11.2 Maintenance Schedule

 CUSTOMER

 QUALIFIED PERSONNEL



DANGER! ELECTRIC SHOCK. Risk of fatal injury. Only electrically qualified personnel should attempt these maintenance procedures.

Maintenance Procedure	Method	Frequency				
		Daily	Weekly	Monthly	Bi-Annually	Annually
Safety						
Safety Switch Function	Set a safe temperature above ambient, and open the door to see if the heater light goes out					
Safety Switch Function	Electrical measurement 					
Over-Temperature Safety Circuit (if fitted)	Set an over-temperature setpoint lower than the displayed temperature and check for an over-temperature alarm as detailed in the separate controller manual					
Over-Temperature Safety Circuit (if fitted)	Electrical measurement 					
Door Mechanism	Ensure the door moves smoothly. Grease the door-guides with high temperature grease if necessary					
Retort / Door Plug	Visual inspection, checking the seal and whether it is free of damage					
Retort / Door Plug	Replacement where necessary					
Chimney / Extraction	Check and clean if necessary					
Electrical Safety (external)	Visual check of external cables and plugs					
Electrical Safety (internal)	Physically check all connections and cleaning of the power plate area					

Function						
Temperature Calibration	Tested using certified equipment, frequency dependent on the standard required					6
Operational Check	Check that all functions are working normally					
Operational Check	Thorough inspection and report incorporating a test of all functions					6
Performance						
Element Circuit	Electrical measurement 					6
Power Consumption	Measure the current drawn on each phase / circuit					6
Hearth	Visual check for fit and damage					
Cooling Fans (if fitted)	Check whether the cooling fans are working					

11.3 Cleaning



Note: Disconnect the product from the electrical supply before carrying out any maintenance procedures.

- With the product switched off, cold, and electrically isolated from the mains, wipe over surfaces using a damp cloth, wrung almost dry.
- **DO NOT** use solvents.
- If necessary, vacuum out the inside of the product to remove any dust or minor debris and dispose of any material removed, in accordance with local regulations, at an approved disposal facility.



Note: Care must be taken to ensure that no moisture enters the furnace or makes contact with any electrical components.

11.4 Safety Switch

When correctly functioning, the safety switch will isolate all live conductors (live and neutral connections) within the heating element circuit(s) when the product door is opened. The safety switch should be checked regularly to ensure that this occurs.

The safety switch should not fail under normal working conditions, however rough handling, exposure to corrosive materials/ environments, or exceptionally frequent use, could compromise the safety system.

Weekly check:

The following check can be carried out by a general operator:

- On the temperature controller, set a safe temperature above ambient. The heater lights should illuminate.
- Open the door and check the heater lights. They should no longer be illuminated.

If the heater lights remain illuminated when the door is open, discontinue use and contact Carbolite Gero Service.

Annual check:

The following checks should be carried out by a qualified electrician, as specified in the "Maintenance Schedule" section of this manual:

- Remove the element access panel and take a voltage measurement from the heating element terminals. Do not attempt to take a reading from the heating element itself as surface oxidation will give an unreliable contact.
- Ensure that power to the heating elements is switched off when the door is opened.

Contact Carbolite Gero Service and discontinue use of the product if it is found that the heating elements are not fully isolated during these checks.

11.5 Calibration

After prolonged use, the controller and/or thermocouple may require recalibration. This is important for processes that require accurate temperature readings or for those that use the product close to its maximum temperature. A quick check using an independent thermocouple and temperature indicator should be made from time to time to determine whether full calibration is required. Carbolite Gero can supply these items. Depending on the controller fitted, the controller instructions may contain calibration instructions.

11.6 After-Sales Service

Carbolite Gero Service has a team of Service Engineers who can offer repair, calibration and preventive maintenance of furnace and oven products both at the Carbolite Gero factory and at customers' premises throughout the world. A telephone call or email often enables a fault to be diagnosed and the necessary parts to be despatched.

In all correspondence please quote the serial number and model type given on the rating label of the product. The serial number and model type are also given on the back of this manual when supplied with the product.

Carbolite Gero Service and Carbolite Gero contact information can be found on the back page of this manual.

11.7 Recommended Spare Parts and Spare Parts Kit

Carbolite Gero can supply individual spare parts or a kit of the items most likely to be required. Ordering a kit in advance can save time in the event of a breakdown.

Please consult Carbolite Gero's Sales Department for details of recommended spare parts.

12.0 Fault Analysis

A. Furnace Does Not Heat Up					
1.	The HEAT light is ON	▶	The heating element has failed	▶	Check also that the SSR is working correctly
2.	The HEAT light is OFF	▶	The controller shows a very high temperature or code such as S.br	▶	The thermocouple has broken or has a wiring fault
		▶	The controller shows a low temperature	▶	The door switch(es) (if fitted) may be faulty or need adjustment
				▶	The contactor/relay (if fitted) may be faulty
				▶	The heater switch (if fitted) may be faulty or need adjustment
				▶	The SSR could be failing to switch on due to internal failure, faulty logic wiring from the controller, or faulty controller
		▶	There are no lights glowing on the controller	▶	Check the supply fuses and any fuses in the furnace control compartment
				▶	The controller may be faulty or not receiving a supply due to a faulty switch or a wiring fault.

B. Product Overheats					
1.	Product only heats up when the instrument switch is ON	▶	The controller shows a very high temperature	▶	The controller is faulty
		▶	The controller shows a low temperature	▶	The thermocouple may be faulty or may have been removed out of the heating chamber
				▶	The thermocouple may be connected the wrong way around
				▶	The controller may be faulty
2.	Product heats up when the instrument switch is OFF	▶	The SSR has failed "ON"	▶	Check for an accidental wiring fault that could have overloaded the SSR

13.0 Decommissioning, Storage and Disposal

13.1 Decommissioning

1. Reduce the setpoint on all temperature controllers to 0°C so that heating cannot begin accidentally when the product is recommissioned
2. Isolate the product from the power supply
3. Allow the product to cool to room temperature
4. Disconnect the product from the power supply
5. Disconnect all additional equipment and external connections e.g. gas supplies

13.2 Storage (Long Term)

Store in a cool, dry place.



Note: If the furnace is exposed to a humid environment during storage, it must be fully dried out before recommissioning. All internal electrical circuits should be checked for signs of moisture. If there are visible signs of moisture, the product should be isolated from the power supply and allowed to dry out at ambient temperature for at least 24 hours. Please contact Carbolite Gero Service for further advice.

13.3 Disposal



Note: This product should only be disposed of in accordance with local regulations and requirements regarding electrical equipment.

Within the European Community the disposal of electrically operated devices is regulated according to guidance based on the EU Directive 2012/19/EU on Waste Electrical and Electronic Equipment (WEEE). Disposal regulations may differ worldwide.

If uncertain, please contact Carbolite Gero for advice on disposal.

ProductLabel

The products covered in this manual are only a small part of the wide range of ovens, chamber furnaces and tube furnaces manufactured by Carbolite Gero for laboratory and industrial use. For further details of our standard or custom built products please contact us at the address below, or ask your nearest stockist.

For preventive maintenance, repair and calibration of all furnace and oven products, please contact:

Carbolite Gero Service

Telephone: + 44 (0) 1433 624242

Fax: +44 (0) 1433 624243

Email: ServiceUK@carbolite-gero.com

Carbolite Gero Ltd,

Parsons Lane, Hope, Hope Valley,
S33 6RB, England.

Telephone: + 44 (0) 1433 620011

Fax: + 44 (0) 1433 621198

Email: Info@carbolite-gero.com

www.carbolite-gero.com

CARBOLITE
GERO 30-3000°C

Copyright © 2022 Carbolite Gero Limited