

Installation, Operation and Maintenance Instructions

Controller Manual

No Controller + 3216CC End Zone Controller

No Controller + 3216CC End Zone Controller

Contents

This manual is for guidance on the use of the Carbolite Gero product specified on the front cover. This manual should be read thoroughly before unpacking and using the furnace or oven. The model details and serial number are shown on the back of this manual. Use the product for the purpose for which it is intended.

1.0	Temperature Controller	4
2.0	3216CC Controller	5
2.1	3216CC	5
2.2	PID control	5
2.3	Operation	5
2.3.1	Controller Layout	5
2.3.2	Keys	6
2.4	Quick Start Guide	6
2.4.1	Operation as a simple controller	6
2.4.2	Changing the Setpoint	6
2.4.3	Using the Controller	6
2.4.4	Understanding User Levels	7
2.5	Setting up the Controller	8
2.5.1	Setpoint Ramp Rate	8
2.5.1.1	Setting Setpoint Ramp Rate	8
2.5.1.2	Running with Ramp Rate	9
2.5.2	Maximum Output Power	9
2.5.3	Customer ID	9
2.5.4	Units	9
2.5.5	Language	10
2.6	Timer	10
2.6.1	Setting the Timer	10
2.6.2	Dwell Timer	10
2.6.3	Delayed Switch On Timer	11
2.6.4	Soft Start Timer	11
2.7	Running a Timer	12
2.7.1	Dwell Timer	12
2.7.2	Power Failure While Using Dwell Timer	13
2.7.3	Running Dwell Timer with Ramp Rate	13
2.7.4	Running Dwell Timer with Ramp Rate & Threshold	13
2.7.5	Delayed Switch on Timer	13
2.7.6	Running Delay Timer with Ramp Rate	14
2.7.7	Delay timer with ramp rate functions	14
2.7.8	Power Failure While Using Delay Timer	15

2.7.9	Soft start Timer	15
2.7.10	Power Failure While Using Soft Start Timer	15
2.7.11	Ramp Rate with Soft Start Timer	16
2.7.12	Time Remaining	16
2.7.13	Alarms	16
2.8	Controller Options	16
2.8.1	Digital Communications - RS232	17
2.8.2	Digital Communications - RS485	17
2.8.3	Comms Address	17
2.8.4	Alarm Option	17
2.9	3216CC Navigation Diagram	19
3.0	2132 Over-Temperature Controller Description (if fitted)	20
3.1	Description	20
3.2	Operation	20
3.2.1	Controls	20
3.2.2	Operation	21
3.2.3	Over-Temperature Operation	21
3.2.4	Over-Temperature Alarm	21
3.2.5	Resetting the Over-Temperature Alarm	21
3.2.6	Sensor Break	21
3.3	Audible Alarm	22
3.4	Navigation Diagram	22
4.0	Operation	23
4.1	Control Method	23
4.2	3-Zone Control Methods	23
A.	Back-to-Back Thermocouples	23
B.	Retransmission of Setpoint	24
C.	Independent Control	25

1.0 Temperature Controller

If this product is fitted with a temperature controller, instructions are provided separately.

2.0 3216CC Controller

2.1 3216CC

The 3216CC Controller is a digital temperature controller which uses PID algorithms to give excellent temperature control when properly set. This controller can only be used as a simple temperature controller, it cannot be programmed.

2.2 PID control

This controller uses PID (Proportional Integral Derivative) temperature control. This type of control uses a complex mathematical control system to adjust the heating power and achieve the desired temperature.





2.3 Operation

2.3.1 Controller Layout

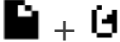

Key	
A	Power Output Indicator
B	Alarm Indicator
C	Remote Indicator (when configured)
D	Page
E	Scroll
F	Down
G	Up
H	Run Indicator
I	Hold Indicator
J	Setpoint Temperature (SP)
K	Measurement Temperature

2.3.2 Keys

Page Key		The page key is used to access level 2 when held down for 3 seconds.
Scroll Key		The scroll key is used to scroll through parameters.
Ack		When pressed simultaneously the ACK function is used to:
Page and Scroll		<ul style="list-style-type: none">• Return to the Home Menu• Acknowledge an alarm if activated.• Reset a program after the program has ended.
Arrow Keys		The arrow keys are used individually to adjust the selected parameters and in combinations to operate a program.



Note: If a parameter is selected and no further action is taken, the display will time out and revert back to the home display in its working level after approximately 1 minute.

2.4 Quick Start Guide

2.4.1 Operation as a simple controller

When switched on, the controller goes through a short test routine and then shows the measured temperature (PV = Process Value) in the upper part of the display and below it, the desired temperature (Setpoint).

2.4.2 Changing the Setpoint

Press Up  or Down  to select the required SP. If the SP is higher than the measured temperature, the OP1 indicator will illuminate in the top left corner of the display, indicating that the controller is calling for power (giving an output).

The controller will immediately attempt to reach the setpoint and then maintain it.

This will cause the product to heat as quickly as possible which may not be appropriate where the product contains sensitive ceramic components. For products with ceramic components, e.g. a tube furnaces fitted with a long ceramic work tube, use the ramp rate feature set with a low heating rate such as 5°C per minute (300°C per hour), to prevent damage.

2.4.3 Using the Controller

The parameters in the controller are first shown by a short code (mnemonic). After 5 Seconds a description of the parameter will scroll once along the display and then revert back to the mnemonic. The scrolling text can be interrupted at any time by a single press of any of the buttons, but will not scroll again until the parameter is

returned to. In this manual the mnemonic will be shown first, followed by the scrolling text in brackets; e.g. PROG <PROGRAM NUMBER>





2.4.4 Understanding User Levels

There are two user levels in the controller; Level 1 (Operator) and Level 2 (Supervisor).

Level 1 (Operator) is for the day to day operation of the controller. These parameters are not protected by a security code.

Level 2 (Supervisor) provides access to additional parameters. Access to this level protected by a security code

To Enter Level 2



1. Press and hold the page key  for 3 seconds.
2. The display will show LEu 1 GOTO
3. Release the page Key
4. Press the up  or down  to choose LEu 2 (level 2)
5. Press the up  or down  to enter the code (Level 2 Code = 9).

If the correct code is entered, PASS should momentarily be displayed and then revert to the level 2 home display.

If an incorrect code is entered the display reverts back to Level 1 home display.

When level 2 operations have been completed, the supervisor must return to Level 1 either manually or by switching the instrument off and back on. There is no time out function.

To Return to Level 1



1. Press and hold the page Key 
2. Press down  to select LEu 1

It is not necessary to enter a code when going from a higher level to a lower level. When level 1 is selected, the display reverts to the home display (See Controller Layout)

Table showing parameters accessible in level 1 and Level 2

Operator LEVEL 1	Supervisor LEVEL 2
home display	home display
	Programming
	Program Status
	Alarms (if configured)
	Current Transformer Input (if configured)
	Comms (if configured)
	Controller set up (if configured)
	Customer Calibration (if configured)

TIP

If while navigating the controller, a parameter has been passed or you need to access parameters which would be at the end of a scroll list, press and hold scroll  and use up  to return to a previous parameter.

2.5 Setting up the Controller

Before using the controller (or during its lifetime) certain parameters may have to be set, depending on specific requirements. To do this the controller must be set to supervisor level (Level 2).

2.5.1 Setpoint Ramp Rate

To control the rate at which the temperature rises to setpoint, the SP.RATE function is used.

Before setting the ramp rate, it is advisable to set the setpoint to a low value, preferably 0 °C (see section 2.4). Once the ramp rate has been set, the required setpoint can be entered from the home menu. Doing so will activate the ramp rate, which can be identified with the run indicator showing on the bottom of the display. While the ramp rate is active the working setpoint will be shown on the lower temperature display (this is the setpoint, set by the ramp rate).



When the process temperature has reached the setpoint value at the given ramp rate, the run indicator will turn off and the instrument will control at the required setpoint temperature.

Any further modifications to setpoint will cause the ramp rate to be activated and the instrument to control as described above.



NOTE: Ensure timer configuration is set to 'none' (see section 2.6) to use the setpoint ramp rate feature without any timer functions.

2.5.1.1 Setting Setpoint Ramp Rate



In supervisor level (level 2).



Press scroll  until the display shows SP.Rate <setpoint rate limit>. Using up  and down  select the ramp rate required, in °C/ Min.

2.5.1.2 Running with Ramp Rate



Press the up  and down  keys at the same time to activate the ramp rate. The "Run" indicator will illuminate and the scrolling text will read <RAMPING> to show the ramp rate is active. The ramp rate will then start from the current process temperature.

When the ramp reaches the setpoint temperature, the "Run" indicator will turn off and the instrument will maintain control at the setpoint.

To put the ramp rate into a hold condition, press the up  and down  keys and release. The "Run" indicator will flash and the scrolling text will read <HOLD> to show the ramp rate is on hold.

To cancel the ramp rate, press and hold the up  and down  keys until the "Run" indicator turns off.

2.5.2 Maximum Output Power

Press scroll  until the display shows OP.HI <OUTPUT HIGH>. Use the up  and down  keys to select the output power required as a percentage. Once the setting is made, turn the instrument switch off and on to power cycle the temperature controller.



Depending on the furnace or oven model, the maximum output power setting OP.Hi may be accessible or locked.

For silicon carbide heated furnaces, the parameter is accessible to allow compensation for element ageing.

In many models the maximum output power setting depends on the supply voltage.

2.5.3 Customer ID

A furnace or oven identification number can be entered if required. This maybe used to identify one of many units for production or quality control systems.

Press scroll  until the display shows ID <CUSTOMER ID>. Use the up  and down  keys to enter your own identification number. This can range from 1-9999.

2.5.4 Units

Press scroll  until the display shows UNITS <DISPLAY UNITS>. Use the up  or down  keys to select the required units.

Mnemonic	Description
NONE	No units (Default °C)
°C	Celsius
°F	Fahrenheit

Mnemonic	Description
°K	Kelvin
PERC	% (shows °C value)

2.5.5 Language

The scrolling text on the 3216 can be shown in different languages, this can only be set at the factory and therefore must be specified at the time of placing an order.

2.6 Timer

2.6.1 Setting the Timer

A timer can be configured to operate in four different modes. These can be selected in level 2 (supervisor level) using the TM.CFG parameter as:-

- None
- Dwell Timer
- Delayed switch on timer
- Soft start timer



None

The timer is turned off, no timer configurations are available, the instrument works as a simple setpoint controller.

Press scroll  until the display shows TM.CFG <TIMER CONFIGURATION>. Using the up  down  select NONE.



2.6.2 Dwell Timer



A dwell timer is used to control a process at a fixed temperature for a defined period. At the end of the time period the controller will switch off the output power to the elements.

Press scroll  until the display shows TM.CFG <TIMER CONFIGURATION>. Using the up  down  select Dwell.

When Dwell parameter is selected, the Timer resolution (TM.RES), Time duration (DWELL) and Timer Threshold (THRES) functions become available.

Press scroll  until the display shows TM.RES < Time resolution >. Use the up  down  to select the timer units in Min or Hours.

Press scroll  until the display shows DWELL < SET TIME DURATION >. Use the up  down  to enter the time duration required.

Press scroll  until the display shows THres < TIMER THRESHOLD >. Use the up  down  to select the temperature threshold that you require the timer to start at. The threshold value is $\pm n$ around the setpoint (n=threshold value).

Example: If the setpoint is set to 800 °C and the timer threshold is set to 2, after the timer is activated it will not start until the process value reaches 798 °C if ramping up or 802 °C if it is cooling.



Note: If the threshold is set to OFF, the timer will either; start to count down as soon as it is activated with the mode keys or if a ramp rate has been set (see section 2.5.1), the timer will start as soon as the ramp reaches the setpoint. (see section 2.7.1)



2.6.3 Delayed Switch On Timer

The delayed switch on timer is used to switch on the output power to the elements after a set time period.

Press scroll  until the display shows TM.CFG <TIMER CONFIGURATION>. Using the up  down  select dELY.

When delay parameter is selected, the Timer Resolution (TM.RES) and Time Duration (DWELL) functions become available.

Press scroll  until the display shows TM.RES < Time Resolution >. Use the up  down  to select the timer units in Min or Hours.

Press scroll  until the display shows DWELL < SET TIME DURATION >. Use the up  down  to enter the time duration required before the output power switches on.

2.6.4 Soft Start Timer

The Soft Start Timer is used to start a process at a reduced setpoint and power. The Soft Start Setpoint is used as a threshold only and is not a control point.

Example: Main Setpoint = 800 °C

Max power limit = 75 % (This may be set at the factory)

Soft Start Setpoint = 600 °C (Threshold)



Soft Start Power Limit = 50% (Cannot be set above max power Limit)



When the timer is running, the maximum power is controlled by the Soft Start Setpoint of 600 °C and the Soft Start Power limit of 50%. This will continue until the timer ends or the current temperature exceeds the Soft Start Setpoint.



When the timer ends or the current temperature exceeds the Soft Start Setpoint, the instrument will start to control using the main setpoint of 800 °C and the Max Power Limit of 75%.



Press scroll  until the display shows TM.CFG <TIMER CONFIGURATION>. Using the up  down  select SF.st.

When Soft Start parameter is selected, the Timer Resolution (TM.RES), Time Duration (DWELL), Soft Start Setpoint (SS.SP) and Soft Start Power Limit (SS.PWR) functions become available.



Press scroll  until the display shows TM.RES < Time resolution >. Use the up  down  to select the timer units in minutes or hours.

Press scroll  until the display shows DWELL < SET TIME DURATION >. Use the up  down  to enter the time duration required, before the instrument starts to control using the main setpoint and max power.











Press scroll  until the display shows SS.SP < Soft Start Setpoint >. Use the up  down  to enter the Soft Start Setpoint.



Press scroll  until the display shows SS.PWR < Soft Start Power Limit >. Use the up  down  to enter the Soft Start Power Limit.

2.7 Running a Timer

- **Run.** This starts the timer.
- **Hold.** This stops the timer at the elapsed time. It will start again from the elapsed time when Run is selected again.
- **Reset.** This sets the timer back to zero. It can be operated again from this state.
- **End** cannot be set – it occurs automatically when the timer has counted down to zero.
- **Acknowledge** any timer after a timer has timed out using ACK function (see section 2.3.2) by pressing the  and  simultaneously.

2.7.1 Dwell Timer

Operation	Action	Indication
To RUN Timer	Press and quickly release  + 	Indicator – RUN = ON Scrolling Display – Timer Running
To HOLD timer	Press and quickly release  + 	Indicator – RUN = Flashing Scrolling Display – Timer Hold
To switch off Timer / Cancel	Press and hold  +  for more than 1 second	Indicator – RUN = OFF Scrolling Display – None Static Text - OFF
To return to home after reset	Press and hold  +  for more than 1 second	Indicator – RUN = OFF Display – A-M <LOOP MODE- AUTO MANUAL OFF> Use the up  or down  to select AUTO
	Timer Ended	Indicator – RUN = OFF Scrolling Text – Timer End Static Text - OFF
To re-RUN Timer	Press and quickly release	Indicator – RUN = ON

	▲ + ▼	Scrolling Display – Timer Running
To RESET timer and return to home menu after timer end	Press and quickly release Ack  + 	Indicator – RUN = OFF Scrolling Display - None
	Press and hold ▲ + ▼ for more than 1 second	Indicator – RUN = OFF Display – A-M <LOOP MODE- AUTO MANUAL OFF> Use the up ▲ down ▼ to select <i>Auto</i>

2.7.2 Power Failure While Using Dwell Timer

If there is a power failure while the timer is operating and the power is subsequently restored, the timer will reset and the static text will display "OFF" until the ▲ + ▼ keys are pressed to re-run the timer.

2.7.3 Running Dwell Timer with Ramp Rate

Set the ramp rate as outlined in section 2.5.1

Set the dwell time as outlined in section 2.6.2.

When the timer is set to operate with a set ramp rate, the timer will not start to count down until the setpoint has been reached with the ramp, at which time the timer will begin time count down.

The scrolling display will indicate "timer running" and the run indicator will be illuminated while the ramp rate is active and during the timer count down, after which the display will indicate the instrument has switched off power to the elements (see section 2.7.7), and the run indicator will switch off.

2.7.4 Running Dwell Timer with Ramp Rate & Threshold

Set the ramp rate as outlined in section 2.5.1.

Set the dwell time as outlined in section 2.6.2.

Set the threshold as outlined in section 2.6.3.

When the timer is set to operate with a set ramp rate and threshold, the timer will not start to count down until the process temperature has reached the threshold value (see example 2.6.3).

The scrolling display will indicate "timer running" and the run indicator will be illuminated while the ramp rate is active, while the process value is reaching the threshold value and during the timer count down, after which the display will indicate the instrument has switched off power to the elements (see section 2.7.1).

2.7.5 Delayed Switch on Timer

Operation	Action	Indication
To RUN Timer	Press and quickly release ▲ + ▼	Indicator – RUN = ON Scrolling Display – Timer

		Running Static Text - OFF
To HOLD timer	Press and quickly release ▲ + ▼	Indicator - RUN = Flashing Scrolling Display - Timer Hold Static Text - OFF
To switch off Timer / Cancel	Press and hold ▲ + ▼ for more than 1 second Indicator - RUN = Off	Scrolling Display - None Static Text - OFF
To return to home menu. After Resetting timer	Press and hold ▲ + ▼ for more than 1 second	Indicator - RUN = Off Display - A-M <LOOP MODE- AUTO MANUAL OFF> Use the up ▲ or down ▼ to select <i>Auto</i>
	Timer Ended	Indicator - RUN = OFF Scrolling Text - Timer End
To re-RUN Timer	Press and quickly release ▲ + ▼	Indicator - RUN = ON Scrolling Display - Timer Running Static Text - OFF

2.7.6 Running Delay Timer with Ramp Rate

Set the ramp rate as outlined in section 2.5.1.

Set the delay time as outlined in section 2.6.3.

When ramp rate is active with a delay timer the run indicator serves two functions:

- Indicates timer is running
- Indicates ramp rate is active

This means that when the timer has timed out the run indicator will still be illuminated if the ramp rate is still active and will continue to be illuminated until the ramp reaches setpoint, at which time it will switch off.

A characteristic of these combinations of parameters is that the scrolling text will continue to indicate timer running when the timer has timed out. Checking whether the timer has timed out or not can be done with the 'T.REMN' function. (see section 2.7.12)

The delay timer with ramp rate will function as outlined in the table above with the addition of the functions in the following table.

2.7.7 Delay timer with ramp rate functions

Timer Ended When ramp rate active	Indicator - RUN = ON - if ramp rate active Scrolling Text - Timer Running
--------------------------------------	--

To HOLD timer	Press and quickly release ▲ + ▼	Indicator – RUN = Flashing Scrolling Display – Timer Hold Static Text - OFF
To switch off Timer / Cancel	Press and hold ▲ + ▼ for more than 1 second	Indicator – RUN = ON - if ramp rate active Scrolling Display – None Static Text - OFF
To re-RUN Timer	Press and quickly release ▲ + ▼	Indicator – RUN = ON Scrolling Display – Timer Running Static Text – OFF

2.7.8 Power Failure While Using Delay Timer

If there is a power failure while the timer is operating and the power is subsequently restored, the timer will reset and will re-run from the power on time.

2.7.9 Soft start Timer

Operation	Action	Indication
To RUN Timer	Press and quickly release ▲ + ▼	Indicator – RUN = ON Scrolling Display – Timer Running Static Text - OFF
To HOLD timer	Press and quickly release ▲ + ▼	Indicator – RUN = Flashing Scrolling Display – Timer Hold Static Text - OFF
To switch off Timer/ Cancel	Press and hold ▲ + ▼ for more than 1 second	Indicator – RUN = OFF Scrolling Display – None Static Text - OFF
	Timer Ended	Indicator – RUN = OFF Scrolling Text – Timer End Running Soft Start Timer

When the soft start timer is set to operate, the scrolling display will indicate “timer running” and the setpoint temperature, not the soft start setpoint.

2.7.10 Power Failure While Using Soft Start Timer

If there is a power failure while the timer is operating and the power is subsequently restored, the timer will reset and will re-run from the power on time.

2.7.11 Ramp Rate with Soft Start Timer

It is not recommended that the ramp rate function be used with a soft start timer.

Note: If the temperature is already above the threshold when the timer is set to operate, the timer will time out immediately.

2.7.12 Time Remaining

The time remaining of any 'Timer' mode can be checked at any time while a timer is active.

To view the time remaining, press scroll  until the display shows T.REMN <TIME REMAINING>.

Note: The time remaining can be modified at any time while the count down timer is operating by pressing the up  or down  key while the time remaining function is active.

2.7.13 Alarms

Alarms are used to alert the operator when a pre-set level has been exceeded or a function error has occurred such as a sensor break. They are indicated by a scrolling message on the display and a flashing red ALM (Alarm) indicator. The alarm may also switch an output – usually a relay to allow external devices to be operated when an alarm occurs. Alarms only operate if they have been configured and are dependant on customer requirements.

How to acknowledge an alarm will depend on the type of latching which has been configured. A non-latched alarm will reset itself when the alarm condition is removed. A latched alarm requires acknowledgement with the "ACK" Function (see section 2.3.2) before it is reset.

If an alarm has been activated the red "ALM" indicator will illuminate and the scrolling text will indicate the type of alarm.

To Acknowledge an alarm and cancel the "ALM" indicator, press ACK function.

Note: The alarm indicator may seem to be permanently on when viewed from above. When an alarm is active the indicator should only be flashing, to confirm this, the controller must be viewed directly from the front.

2.8 Controller Options

As options can be ordered in a variety of combinations and for a variety of purposes, exact instructions are not given here. The full Eurotherm manual may be required to determine customer parameter settings. To reveal or hide parameters in the controllers it is necessary to go into configuration mode, a security code is needed. Please consult Carbolite Gero.

2.8.1 Digital Communications - RS232

If the RS232 option is supplied, the furnace is fitted with one sub-miniature D-socket connected to the controller comms module. RS232 is suitable for direct connection to a personal computer (PC) using a "straight through" cable as follows (the linked pins at the computer end are recommended but may not be necessary). The cable is usually 9-pin at the furnace end and 9-pin at the computer, but other alternatives are shown in parentheses.

Product end of cable female (25-pin) 9-pin			RS232 Cable: product to PC	Computer end of cable 9-pin (25-pin) male		
Rx	(2)	3	—————	3	(2)	Tx
Tx	(3)	2	—————	2	(3)	Rx
Com	(7)	5	—————	5	(7)	Com
				7,8 1,4,6	(4,5) (6,8,20)	Link together Link together

2.8.2 Digital Communications - RS485

If an RS485 option is supplied, the furnace is fitted with two D-sockets. Connection between products is by "straight" cable as follows:

Product end of cable female (25-pin) 9-pin			RS485 Cable: product to PC	Computer end of cable 9-pin (25-pin) female		
-	(2)	3		3	(2)	Tx
+	(3)	2		2	(3)	Rx
Com	(7)	5		5	(7)	Com

2.8.3 Comms Address

Typically the comms address is set to 1, but this can be changed. In the case of RS485 and multiple instruments it is necessary to set different addresses. To change the address value, access the level 2 list. In level 2 press the page key until the COMMS parameter is displayed. Press up ▲ down ▼ to select the address value.

2.8.4 Alarm Option

When an alarm board is fitted, which consists of a relay with voltage free contacts, for operator use, the contacts are taken to a panel plug on the control panel, wired as indicated:

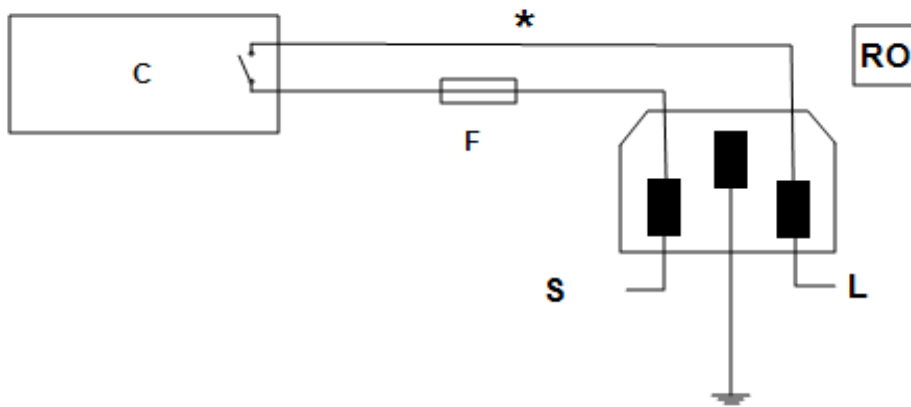

Key	
C	Temperature Controller
F	Fuse (2A)
S	Supply
L	Load
*	Normally open relay contacts
RO	Relay Output 240V 2A MAX

The purpose of the 2 amp fuse is to break the circuit to prevent overloading on the circuit due to high voltage.

The instrument configuration and parameters available to the operator depend on the customer requirements.



Before handling the controller: wear an anti-static wrist strap or otherwise avoid any possibility of damage to the unit by static electricity. Refer to the detailed instructions supplied with the replacement controller.

Ease apart the two lugs at the side; grip the instrument and withdraw it from its sleeve; push in the replacement.

2.9 3216CC Navigation Diagram

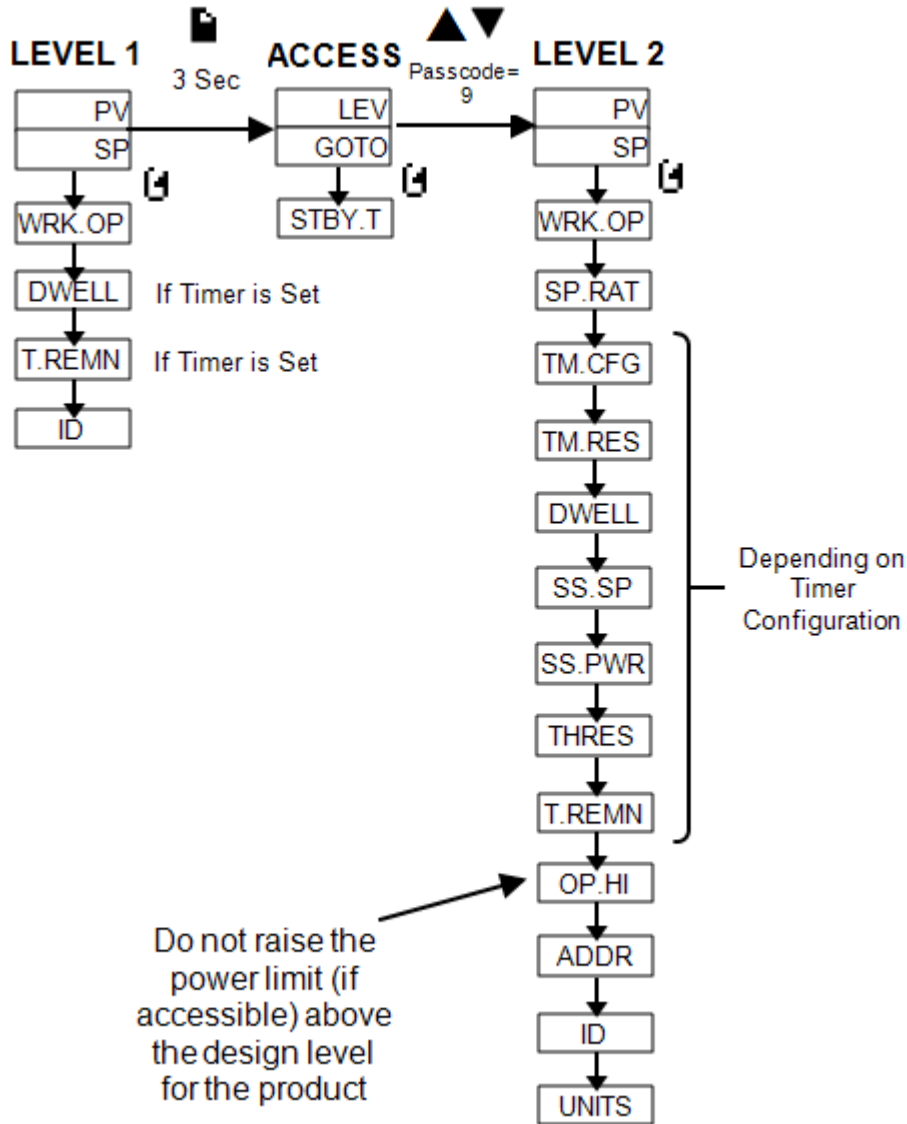

3.0 2132 Over-Temperature Controller Description (if fitted)

3.1 Description

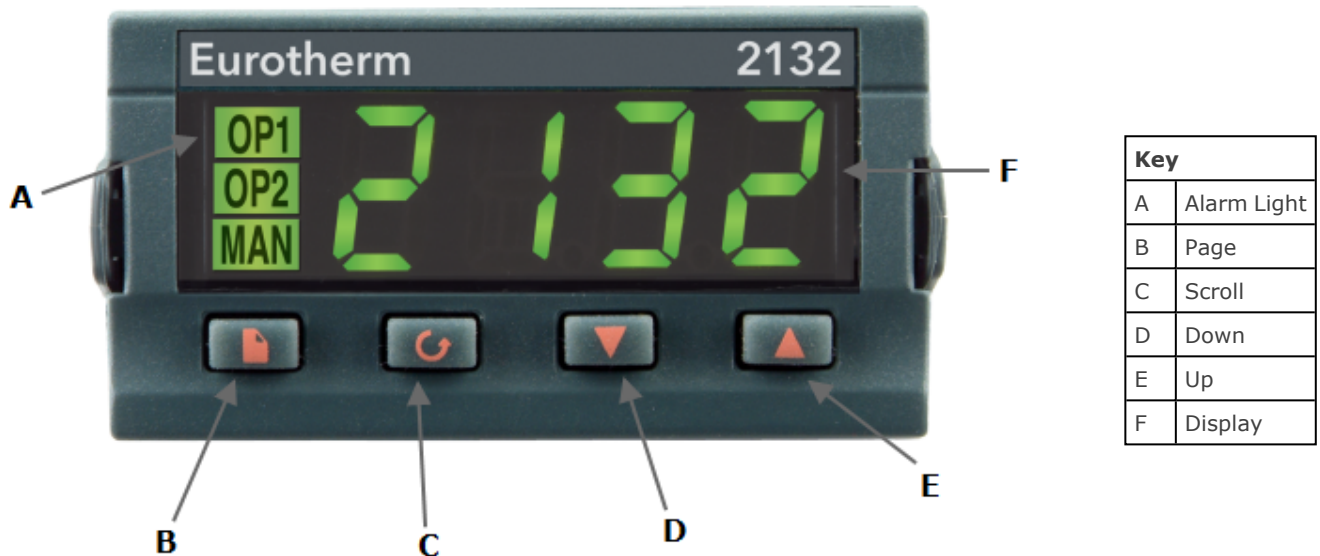

This over-temperature controller is fitted and supplied ready to use by Carbolite Gero. It is a digital instrument with a latching alarm, requiring no additional panel controls. The controller features easy setting of over-temperature setpoint and reading of current temperature by the over-temperature sensor.

3.2 Operation

3.2.1 Controls

Most Carbolite Gero products are fitted with an instrument switch which cuts off power to the controller and other parts of the control circuit.

To operate the controller, power must be supplied to the product and the instrument switch must be on. If a time switch is included in the product circuit, this must be in the 'ON' position.

When an over-temperature condition occurs, the controller cuts the power to a contactor, which in turn cuts power to the heating elements. Power is not restored until the controller is 'reset'.

Some components will operate after the over-temperature feature isolates the power supply e.g. cooling fans will continue to operate, provided that there is a power supply to the product. In some cases the product may not do so, if other options (such as a door switch) are fitted.

3.2.2 Operation

When switched on, the controller lights up, goes through a short test routine and then displays the measured temperature or the over-temperature setpoint.

The page key  allows access to parameter lists within the controller.

A single press of the page key  displays the temperature units, normally set to °C; further presses reveal the lists indicated in the navigation diagram.



The scroll key  allows access to the parameters within a list. Some parameters are display-only; others may be altered by the operator.

A single press of the scroll key  in the 'Home' list displays the temperature units; further presses reveal the parameters in the current list indicated in the navigation diagram.

To return to the 'Home' list at any time, press page  and scroll  together, or wait for 45 seconds.

The down  and up  keys are used to alter the setpoint or other parameter values.

3.2.3 Over-Temperature Operation

Use down  and up  to alter the over-temperature setpoint. This should normally be set a little above the working temperature (for example 15 °C above). The product is supplied with the over-temperature set at 15 °C above the furnace or oven maximum working temperature.

Press scroll  twice view the present temperature as measured by the over-temperature controller. Press it twice, the first press shows the temperature units (°C).

3.2.4 Over-Temperature Alarm

If an over-temperature condition occurs, the OP2 indicator flashes and an alarm message 2FSH also flashes, alternating with the setpoint. Power to the heating elements is disconnected.

3.2.5 Resetting the Over-Temperature Alarm

To acknowledge the alarm press scroll  and page  together.

If the alarm is acknowledged while there is still an over-temperature condition, the OP2 indicator stops flashing but continues to glow. The 2FSH alarm continues to flash until the over-temperature condition is cleared (by the temperature falling), when normal operation resumes.

If the alarm is acknowledged when the temperature has dropped (or after the over-temperature setpoint has been raised) so that the over-temperature condition no longer exists, then the furnace or oven immediately resumes normal operation.

3.2.6 Sensor Break

The over-temperature cut-out system also operates if the over-temperature control thermocouple breaks or becomes disconnected. The message S.br flashes where the measured temperature is normally displayed.

3.3 Audible Alarm

If an audible alarm is supplied for use with the over-temperature controller, it is normally configured to sound on over-temperature condition and to stop sounding when the alarm is acknowledged as given in section 3.2.

Note: the alarm may sound during controller start-up.

3.4 Navigation Diagram

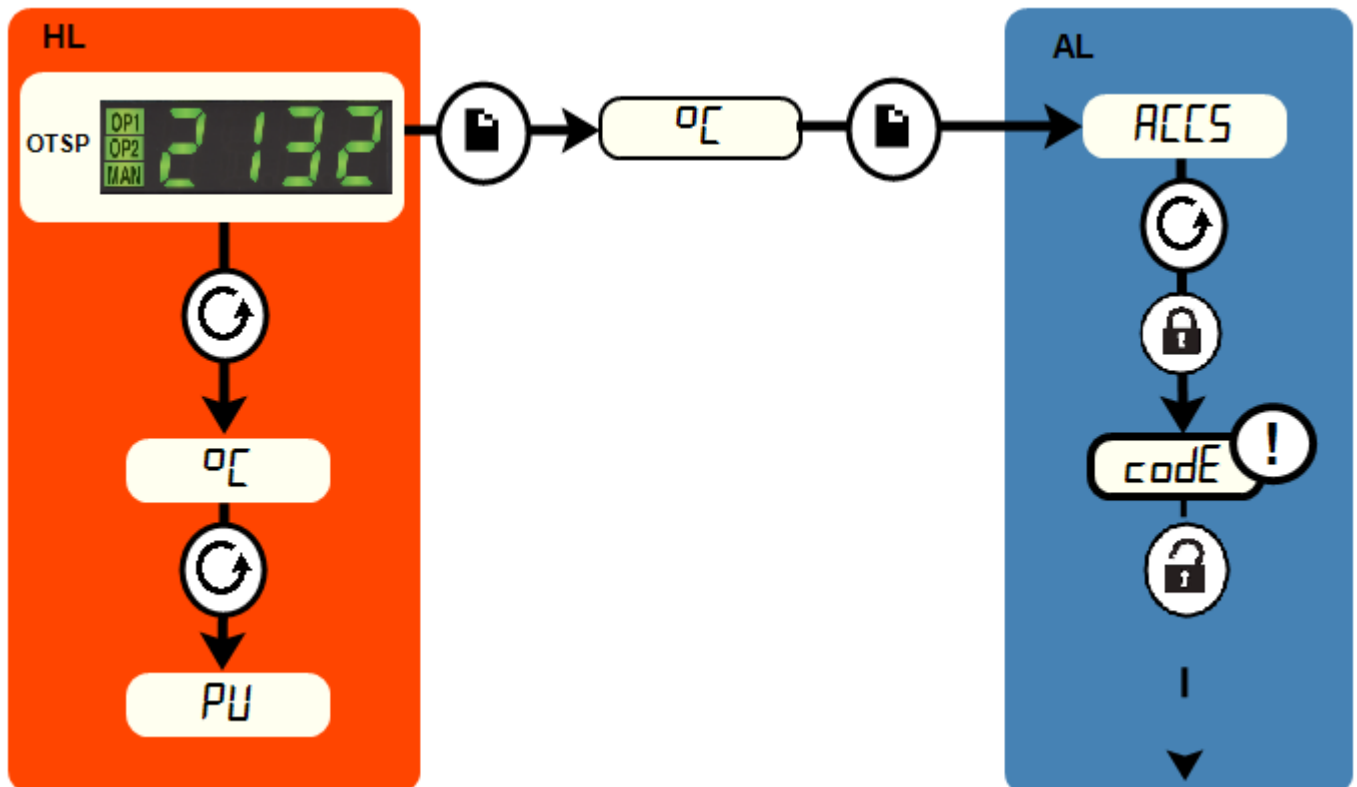

HL	Home List		Page Key	→	Black = Progress
OTSP	Over-Temperature Setpoint		Scroll Key		Dashed = Through to other options
AL	Access List		For factory access to list and parameters not available to the operator.		

4.0 Operation

4.1 Control Method

Set the three temperature controllers to the desired setpoints. The setting and operation of the end zone controllers depends on the 3-zone control options selected when the product was ordered. These options are described in the 3-zone control methods section.

Note: Despite its vertical orientation, the heated zones of the KVZ model are labelled to correspond with the relevant control module on the CC-T1 touchscreen controller display (Left, Main, Right).

4.2 3-Zone Control Methods

There are three different control options (A, B & C).

- (A) Back to back thermocouples
- (B) Retransmission of Setpoint
- (C) Independent control

The models listed in this manual are designed to achieve an extended uniform temperature zone, through use of three control zones, rather than achieving different temperatures in each zone.

For A & B, the control zones are linked so that they all follow the centre zone controller in a master-slave approach

Note:

- Option A is **NOT** applicable when using the CC-T1 controller
- Option B is **NOT** applicable when using the Eurotherm 2132 End Zone Controller

A. Back-to-Back Thermocouples

This is the most commonly supplied option. The centre zone of the tube furnace is controlled directly by the centre zone temperature controller. The two end zone thermocouples are wired in opposition to the centre zone reference thermocouple. If the temperatures of the centre and end zones are the same then 0°C will be displayed on the end zone controllers. If the end zone temperatures are either higher or lower than the centre zone, the end zone controller will display the difference in temperature (higher = positive value, lower = negative value).

It is best practice to set the setpoint of the two end zone controllers to zero. Alternatively, a small temperature difference (offset) can be created by setting a non-zero value, for example to compensate for heat losses at the end or where using a gas

flow. However, the sum of the centre zone controller setpoint and the end zone controller offset MUST NOT exceed the furnace maximum temperature.

To alter the setpoint with the display showing the Home screen, press Down or Up once to display the setpoint and then press again or hold down to adjust it. The display returns to the measured temperature when no key is pressed for a short period of time.

Sometimes a furnace using this type of control does not cool down because the end zones lose heat first and therefore the end zone controllers try to compensate for this by switching on the end zone elements, preventing the furnace from cooling.

B. Retransmission of Setpoint

Three independent thermocouples are connected to three controllers. The three controllers are linked together and the centre zone controller communicates the desired setpoint to the end zone controllers. If the centre zone controller is set to a setpoint or is running a program, the end zone controllers will automatically follow.

For products with the CC-T1 controller, please refer to the separate CC-T1 controller manual for details on enabling and disabling setpoint retransmission.

For other products, additional communication modules are fitted in the controllers. The communication between the controllers of the Eurotherm 3000 series is known as Broadcast communications. It is possible to switch off the linked control and allow the controllers to work independently. In the level 2 menu of the end zone controllers (see controller operating instruction), scroll to L-r. Where the end zone controller is a 3216 use the up down buttons and select NO. Where the end zone controller is a 3508 use the up down buttons to select SP1, (SP1 = Local, and SP2 = Remote). There is no need to alter the centre zone controller.

It is possible to set an offset (local trim) between the centre and end zone controllers. This can be either a positive or negative difference from the centre zone temperature. Once entered, this offset will always be added to, or subtracted from, the retransmitted setpoint temperature.

For products with the CC-T1 controller, please refer to the separate CC-T1 controller manual for details on how to set an offset trim.

To make this adjustment on other controllers, enter the level 2 menu of the end zone controllers (see controller operating instruction), scroll to LOC.T (local trim) and use the up down buttons to enter the desired positive or negative value. This will then be added to, or subtracted from, the end zone set temperature. There is no need to alter the centre zone controller.

C. Independent Control

The three controllers are completely independent. Note that it is not possible to maintain very different temperatures in the three zones because of heat transfer between the zones. The models listed in this manual are designed to achieve an extended uniform temperature zone by the use of three control zones rather than achieving different temperatures in each zone.

ProductLabel

The products covered in this manual are only a small part of the wide range of ovens, chamber furnaces and tube furnaces manufactured by Carbolite Gero for laboratory and industrial use. For further details of our standard or custom built products please contact us at the address below, or ask your nearest stockist.

For preventive maintenance, repair and calibration of all furnace and oven products, please contact:

Carbolite Gero Service

Telephone: + 44 (0) 1433 624242

Fax: +44 (0) 1433 624243

Email: ServiceUK@carbolite-gero.com

Carbolite Gero Ltd,

Parsons Lane, Hope, Hope Valley,
S33 6RB, England.

Telephone: + 44 (0) 1433 620011

Fax: + 44 (0) 1433 621198

Email: Info@carbolite-gero.com

www.carbolite-gero.com

CARBOLITE
GERO 30-3000°C

Copyright © 2021 Carbolite Gero Limited