

Installation, Operation and Maintenance Instructions 1800°C Bottom Loading Furnace - BLF Model: 8 Litres No Controller

BLF 18/8 + No Controller

Contents

This manual is for guidance on the use of the Carbolite Gero product specified on the front cover. This manual should be read thoroughly before unpacking and using the furnace or oven. The model details and serial number are shown on the back of this manual. Use the product for the purpose for which it is intended.

1.0	Symbols and Warnings	4
1.1	Switches and Lights	4
1.2	General Warnings	4
1.3	Prerequisites to Use	5
2.0	Installation	6
2.1	Unpacking and Handling	6
2.2	Siting and Setting Up	6
2.3	Fitting the Chimney and Heating Elements	7
2.4	Electrical Connections	8
3.0	Temperature Controller	10
4.0	Operation	11
4.1	Operating Cycle	11
4.2	Emergency Stop Button	11
4.3	General Operating Advice	11
4.4	Atmospheres & Corrosive Materials	12
4.5	Operator Safety	13
4.6	Notes on Temperature Control	13
4.7	Insulation Cracking	13
4.8	Thermocouple Warnings	13
4.9	Inverted Crucible Option	14
4.10	Element Protection Tube Option	14
5.0	Maintenance	15
5.1	General Maintenance	15
5.2	Maintenance Schedule	15
5.2.1	Cleaning	17
5.3	Calibration	17
5.4	After-Sales Service	17
5.5	Recommended Spare Parts and Spare Parts Kit	17
5.6	Power Adjustment (Controller)	17
5.7	Power Adjustment (Thyristor)	18
6.0	Repairs and Replacements	19
6.1	Safety Warning - Disconnection from Power Supply	19

6.2	Safety Warning - Refractory Fibre Insulation	19
6.3	Safety Warning - Molybdenum Disilicide Elements	20
6.4	Temperature Controller Replacement	20
6.5	Fuse Replacement	20
6.6	Thermocouple Replacement	20
6.7	Element Protection Tube Option Replacement Procedure	21
6.8	Insulation Replacement	21
6.9	Element Installation and Replacement	22
7.0	Fault Analysis	25
A.	Furnace Does Not Heat Up	25
B.	Product Overheats	26
8.0	Wiring Diagrams	27
8.1	215-1-1009	27
8.2	215-1-1007	28
9.0	Fuses and Power Settings	29
9.1	Fuses	29
9.2	Power Settings	29
10.0	Specifications	30
10.1	Environment	30

1.0 Symbols and Warnings

1.1 Switches and Lights



Instrument switch: when the instrument switch is operated the temperature control circuit is energised.



Heat light: the adjacent light glows or flashes to indicate that power is being supplied to the elements.

1.2 General Warnings



DANGER – Electric shock. Read any warning printed next to this symbol.

WARNING: Risk of fatal injury.



DANGER – Hot surface. Read any warning printed next to this symbol.

WARNING: All surfaces of a product may be hot.



DANGER – Read any warning printed next to this symbol.

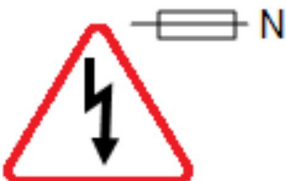

Caution – Double Pole/Neutral Fusing

1.3 Prerequisites to Use

Prior to the commissioning and use of this product, all personnel involved in its installation, operation and maintenance must be deemed competent and have:

- Read and understood the information contained within this manual
- Received the relevant training with regard to safety and operation of the product
- Been provided with the appropriate PPE (Personal Protective Equipment) required for the safe operation of this product

Note: The customer is responsible for ensuring that all of the above conditions are satisfied before the product is commissioned for use.



Note: Unless otherwise specified, the customer is responsible for the installation of this product and the safe connection of any additional equipment and gas or liquid supply lines.

2.0 Installation

2.1 Unpacking and Handling

When unpacking or moving the product always lift it by its base. Do not use the door or any other protruding parts. The product contains a transformer and is heavy: use two or more people to carry the product.

Some models may alternatively be lifted by fitting lifting bolts to captive threads in the top of the case.

Remove any packing material.



NOTE: This product contains Refractory Ceramic Fibre (also known as Alumino Silicate Wool - ASW). For precautions and advice on handling this material see section 6.2.

2.2 Siting and Setting Up

Place the product on a level surface in a well ventilated area.

Site away from other sources of heat and on a non-flammable surface that is resistant to accidental spillage or hot materials.

The surface on which the equipment is mounted should be stable and not subject to movement or vibrations.

The height of the mounting surface is important to avoid operator strain when loading and unloading samples.

Unless otherwise stated elsewhere in this manual, ensure that there is **at least 150 mm** of free space around the back and sides of the product. Clear space is required above the product to dissipate heat.

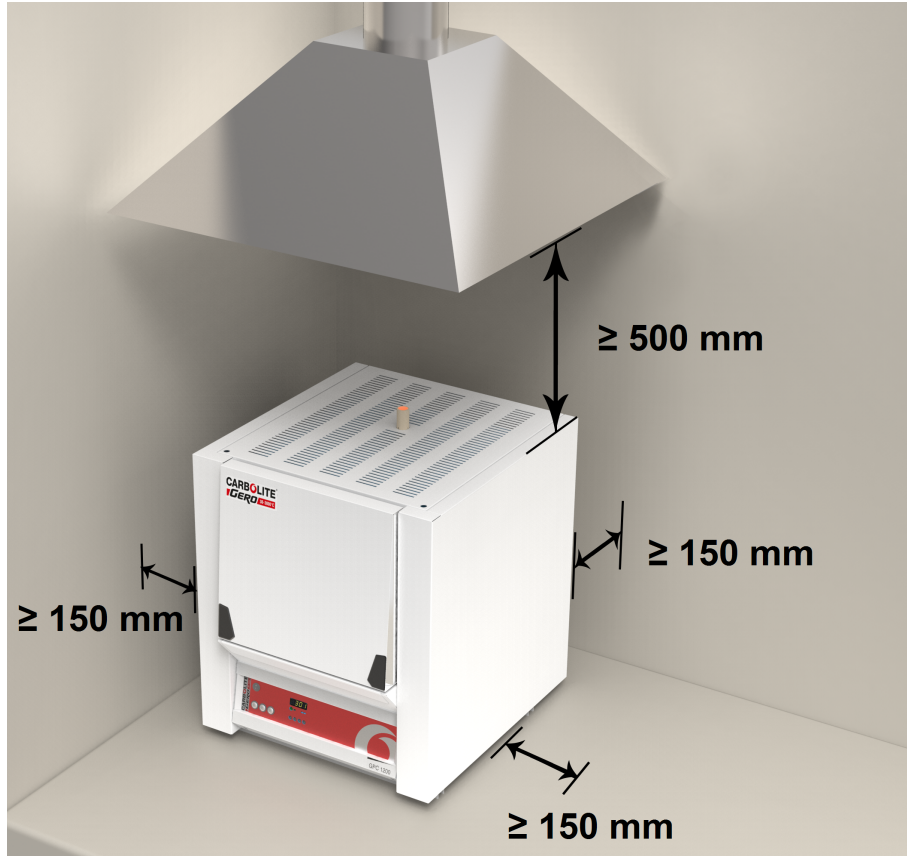

Depending on the application of the product, it may be appropriate to position it under an extraction hood. Ensure the extraction hood is switched on during use.

Ensure that the product is placed in such a way that it can be quickly switched off or disconnected from the electrical supply.



Under no circumstances should any objects be placed on top of the product. Always ensure that any vents on the top of the product are clear of any obstruction. Always ensure all cooling vents and cooling fans (if fitted) are clear of any obstruction.

2.3 Fitting the Chimney and Heating Elements



Please refer to the Element Installation and Replacement in section 6.0. Wear eye protection when handling the heating elements.

The molybdenum disilicide elements are **EXCEPTIONALLY FRAGILE** and are packed separately, together with other items shown in the list.

separately packed items	BLF
Elements	9
Element Clamps	18
Elements Clips*	18
Braids*	1 set

separately packed items	BLF
Separators	9
* or combined clips and braids may be supplied	

Transit Clamps – dependent on model: the example shown here is for the 3 litre models; remove any transit clamps as shown. Fit the ceramic chimney to the hole that exits the top of the chamber. Most models are supplied with an insulation piece to fit around the chimney; fit this insulation.

Remove the complete top access panel using the hidden screw in holes in the top of the panel; loosen the screws two turns and remove the panel.

Fit the heating elements vertically into the chamber. Handle the elements with great care.

Connect the aluminium braids securely as indicated in the element installation instructions.

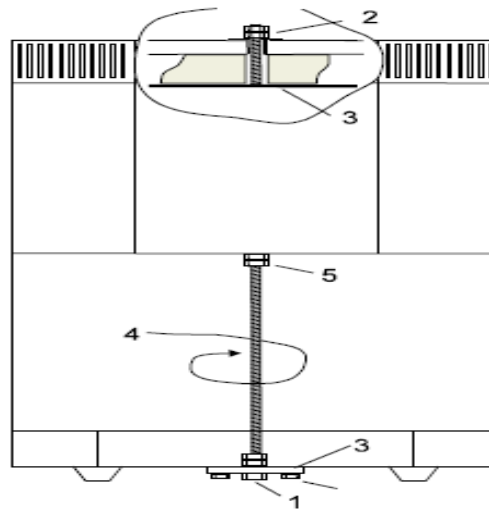

2.4 Electrical Connections



Connection by a qualified electrician is recommended.

This model is designed for connection to a three phase power supply. This may be with neutral or delta, but a product must only be connected to the type and voltage of supply for which it was made.

Check the product rating label before connection. The supply voltage should agree with the voltage on the label and the supply capacity should be sufficient for the current on the label.

The supply should be fused at the next size equal to, or higher than the current on the label. This manual contains a table of the most common fuse ratings.

When the mains cable is factory fitted, internal fuses are also fitted. It is essential that the operator ensures that the product is correctly fused.

Products with a factory fitted supply cable are designed to be wired directly to an isolator or fitted with a line plug.

Products without a factory fitted supply cable require a permanent connection to a fused and isolated supply. The product's electrical access panel should be temporarily removed, and connections made to the internal terminals.

When connecting the product to the power supply, the plug or isolating switch should be accessible, easy to remove, and within reach of the operator.

The supply **MUST** incorporate an earth (ground).

Supply	Terminal Label	Cable Colour	Supply Type
3-phase	L1	Black	to phase 1
	L2	Black	to phase 2
	L3	Black	to phase 3
	N	Light Blue	to neutral (except delta)
	PE	Green/ Yellow	to earth (ground)

3.0 Temperature Controller

If this product is fitted with a temperature controller, instructions are provided separately.

4.0 Operation

4.1 Operating Cycle

This product is fitted with an instrument switch which cuts off power to the control circuit.

Connect the product to the electrical supply.

The cooling fans should automatically operate.

The furnace is fitted with a pair of gates that have a safety switch. The hearth can only be lowered or raised if the gates are closed. The furnace is also fitted with a radiation shield. The hearth can only be raised or lowered if this is in the open position.

Check the hearth control switch for correct operation. The spring return switch stops the hearth in any position, but over-travel is automatically limited. Load the furnace and raise the hearth.

Turn on the instrument switch to activate the temperature controllers. The controllers illuminate and go through a short test cycle.

Set the over-temperature controller to a temperature a little (e.g. 15 °C) above the maximum setpoint of program temperature, according to the instructions supplied.

The product will heat up according to the controller setpoint or program, unless a time switch is fitted and switched off. The heat light glows brightly at first, more dimly as the product temperature approaches a program setpoint.

Over-Temperature option only. If the over-temperature circuit has tripped, an indicator on the over-temperature controller flashes and the heating elements are isolated. Find and correct the cause before resetting the over-temperature controller according to the instructions supplied.

To switch the furnace off, set the instrument switch to off. The case cooling fans remain on and the chamber can be unloaded. Leave the fans on until the product cools to below 300 °C. If the product is to be left off unattended, isolate it from the electrical supply.

4.2 Emergency Stop Button

Pushing the emergency stop button will stop the hearth from moving and prevent the elements from heating.

Once the button has been pushed, twist the emergency stop button to reset.

4.3 General Operating Advice



Heating element life is shortened by overheating. Do not leave the product at high temperature when it is not required. The maximum temperature is shown on the product rating label and in section 10.0 towards the back of this manual.

When heating large objects, in particular poor conductors, avoid shielding the thermocouple from the heating elements. The thermocouple is intended to sense the temperature near the heating elements. However, if a large object is placed in the chamber it may record the average temperature of the object and the elements, this can lead to overheating of the elements. Allow large objects to gain heat at a lower temperature and then reset the controller to a temperature close to the desired maximum, or heat using a slowly controlled ramp rate. For more information refer to the controller instructions.

The product's elements are very susceptible to mechanical shock. Take great care when loading or unloading the chamber. If it is necessary to load or unload work at elevated temperatures, keep the door open for as short a period as possible. The insulation cools quickly and may crack though thermal shock.

For improved insulation and element life it is recommended to heat and cool at a slow ramp rate e.g. 5 °C/minute, and to avoid opening the door at high temperatures.

On first installing the elements and on subsequent element replacement, operate the product at 1500 °C for an hour to create a protective glaze on the element surface.

4.4 Atmospheres & Corrosive Materials

In oxidising atmospheres, metal oxides react with the silica layer on the surface of the elements and may lead to premature failure. Protect the elements from splashes of molten metal and dust when loading the furnace and from fumes developed when melting, especially from fluxes. Also avoid compounds with a high alkali content.

The furnace is designed for use up to its maximum temperature in oxidising atmospheres, but can be operated successfully in neutral or carburising atmospheres. It may be used with nitrogen, argon or helium atmospheres to 1600 °C. Reducing atmospheres are not recommended. Sulphur dioxide is not harmful in low concentrations. However chlorine and fluorine attacks oxidised elements and should be avoided. A harmful gas is produced and collects in poorly ventilated spaces.

The furnace is not recommended for burning off carbonaceous materials. Other Carbolite Gero furnaces are available for this application.

When an optional gas inlet is fitted there is a label near the inlet saying "INERT GAS ONLY".

The chamber is not gas tight, the gas usage may be high and the chamber is always likely to contain some air. Residual oxygen of approximately 1% to 2% is to be expected.

Periodically operate the furnace in air at 1500 °C for an hour to ensure the protective glaze on the elements surface is maintained.

The hearth can be protected from abrasion, if required, by the provision of a secondary plate. This consumable item can either be in lightweight ceramic fibre or in dense, hard-wearing alumina refractory.

4.5 Operator Safety



This product incorporates a safety switch which interrupts the heating element circuit when the furnace is opened. This prevents the operator touching a live heating element and also prevents the product from heating up if the furnace is left open. The operation of this switch should be checked periodically.



Depending on use, the surfaces in the working chamber and the chamber load may still be very hot after the appliance is switched off. Touching these surfaces may cause burns. Use suitable personal protective equipment or wait until the appliance cools down to ambient temperature.

Before removing a hot object from the product, make sure there is a safe place to put it down. If necessary use tongs, face masks and heat resistant gloves. Heat resistant clothing and face protection can guard against the effects of radiated heat when the furnace is open.

When the product is opened during operation there is considerable radiated heat. Do not keep any flammable objects near the product, nor objects which could be damaged by radiated heat.

4.6 Notes on Temperature Control

This product is designed for heating and cooling at controlled rates. The heating and cooling rates can be set in the temperature programmer. The programmer enables the furnace to heat or cool at slower rates as desired and variable "hold" (dwell) periods can be programmed as required.

The programmer is used in conjunction with a phase angle thyristor power controller, which incorporates a current limit potentiometer pre-set by Carbolite Gero, but which will require adjustment in the event of change of supply voltage.

The elements are connected in series across the low voltage output of a transformer housed in the furnace case. Molybdenum disilicide elements do not age, if an element fails it is not necessary to replace the complete set.

4.7 Insulation Cracking

The insulation material in this furnace is susceptible to surface cracking as a result of temperature cycling. This is a normal occurrence and such cracking is not detrimental to the performance of the overall life of the furnace, under normal operation.

4.8 Thermocouple Warnings

(1) The output from 1700-1800 °C thermocouples when used regularly at temperatures greater than 1650 °C can deteriorate and decrease with age faster than if used at temperatures below 1650 °C; this will cause the furnace to operate at temperatures higher than indicated.

Operators are advised to periodically check the thermocouple output, either by a calibration test or by comparing the output with a new reference thermocouple which has been subjected to high temperatures for a minimum length of time.

Failure to check the thermocouple regularly may result in overheating of the work and the furnace, with consequential damage to both.

(2) The thermocouples fitted to these models give very low outputs below approximately 600 °C and do not give accurate readings at low temperatures. They may show a negative temperature when the furnace is started from cold.

This furnace is not intended to operate with a setpoint below 600 °C.

4.9 Inverted Crucible Option

Take special care over safety considerations: ensure that there is a safe surface on which to place the crucible when hot. If the process permits, avoid lowering the hearth when the chamber is hot.

Depending on the height of the work-piece, it may be necessary to hold the crucible up in the chamber when placing the work-piece on the hearth; ensure that appropriate tongs are available before starting.

Clamp Option

This option assists the placing of the crucible over tall work-pieces. The "clamp" is provided in the form of a support shelf which can be fitted to a hinge on the case and a pair of insulated tongs.

With the hearth lowered, place the support shelf on the hinge and swing to the side. Use the tongs to lift the crucible up into the chamber, swing the shelf to the centre and lower the crucible.

Place the work-piece. Reverse the procedure above and carefully lower the crucible over the work-piece. Remove the shelf before raising the hearth.

4.10 Element Protection Tube Option

For application where the material being heated may give off fumes or splash, an inverted crucible can be fitted to protect the elements that is permanently located in the furnace body.

The tubes utilised for element protection within the BLF range of furnaces are fragile and extreme care should be taken when handling them.

5.0 Maintenance

5.1 General Maintenance

Preventive rather than reactive maintenance is recommended. The type and frequency depends on the product use; the following are recommended.















5.2 Maintenance Schedule

 CUSTOMER

 QUALIFIED PERSONNEL



DANGER! ELECTRIC SHOCK. Risk of fatal injury. Only electrically qualified personnel should attempt these maintenance procedures.

Maintenance Procedure	Method	Frequency				
		Daily	Weekly	Monthly	Bi-Annually	Annually
Safety						
Safety Switch Function	Set a safe temperature above ambient, and lower the hearth to see if the heater light goes out					
Safety Switch Function	While lowering or raising the hearth operate the emergency stop button to prove that it functions correctly.					
Safety Switch Function	Check that the hearth will not raise or lower with the cage open.					
Safety Switch Function	Electrical measurement 					
Over-Temperature Safety Circuit (if fitted)	Set an over-temperature setpoint lower than the current displayed temperature and check for an over-temperature alarm as detailed in this manual					
Over-Temperature Safety Circuit (if fitted)	Electrical measurement 					
Hearth	Visual inspection, checking the seal and whether it is free of damage					
Hearth	Replacement where necessary					
Cooling Fans (if fitted)	Check whether the cooling fans are working					
Chimney / Extraction	Check and clean if necessary					
Electrical Safety (external)	Visual check of external cables and plugs					
Electrical Safety (internal)	Physically check all connections and cleaning of the power plate area					

Function						
Temperature Calibration	Tested using certified equipment, frequency dependent on the standard required					6
Operational Check	Check that all functions are working normally					
Operational Check	Thorough inspection and report incorporating a test of all functions					6
Performance						
Element Circuit	Electrical measurement 					6
Power Consumption	Measure the current drawn on each phase / circuit					6

5.2.1 Cleaning

Soot deposits may form inside the furnace, depending on the process. At appropriate intervals remove these by heating as indicated in the General Operation Notes.



The product's outer surface may be cleaned with a damp cloth. Do not allow water to enter the interior of the case or chamber. Do not clean with organic solvents.

5.3 Calibration

After prolonged use, the controller and/or thermocouple may require recalibration. This is important for processes that require accurate temperature readings or for those that use the product close to its maximum temperature. A quick check using an independent thermocouple and temperature indicator should be made from time to time to determine whether full calibration is required. Carbolite Gero can supply these items.

Depending on the controller fitted, the controller instructions may contain calibration instructions.

5.4 After-Sales Service

Carbolite Gero Service has a team of Service Engineers who can offer repair, calibration and preventive maintenance of furnace and oven products both at the Carbolite Gero factory and at customers' premises throughout the world. A telephone call or email often enables a fault to be diagnosed and the necessary parts to be despatched.

In all correspondence please quote the serial number and model type given on the rating label of the product. The serial number and model type are also given on the back of this manual when supplied with the product.

Carbolite Gero Service and Carbolite Gero contact information can be found on the back page of this manual.

5.5 Recommended Spare Parts and Spare Parts Kit

Carbolite Gero can supply individual spare parts or a kit of the items most likely to be required. Ordering a kit in advance can save time in the event of a breakdown.

Each kit consists of one thermocouple, one sheath, one power thyristor, one door insulation piece and a set of elements, clips and braids, element clamps and insulators. Individual spare parts are also available.

When ordering spare parts please quote the model details as requested above.

5.6 Power Adjustment (Controller)

The product's controller incorporates a power limit parameter OP.Hi, which is usually inaccessible to the operator.

The correct setting for the power limit depends on the supply voltage, table given in section 9.0

5.7 Power Adjustment (Thyristor)

The current-limiting thyristor stacks which control power to the elements are fitted with an adjustable resistor which is factory set to limit the maximum current supplied. In the event of a change of supply voltage, or the fitting of a new thyristor, further adjustment may be required.

The maximum element currents for this model are listed in section 9.0. Please contact Carbolite Gero for further information.

6.0 Repairs and Replacements

6.1 Safety Warning - Disconnection from Power Supply



Immediately switch the product off in the event of unforeseen circumstances (e.g. large amount of smoke). Allow the product to return to room temperature before inspection.



Always ensure that the product is disconnected from the electrical supply before repair work is carried out.

Caution: Double pole/neutral fusing may be used in this product.

6.2 Safety Warning - Refractory Fibre Insulation



Insulation made from High Temperature Insulation Wool Refractory Ceramic Fibre, better known as (Alumina silicate wool - ASW).

This product contains **alumino silicate wool** products in its thermal insulation. These materials may be in the form of blanket or felt, formed board or shapes, slab or loose fill wool.

Typical use does not result in any significant level of airborne dust from these materials, but much higher levels may be encountered during maintenance or repair.

Whilst there is no evidence of any long term health hazards, it is strongly recommended that safety precautions are taken whenever the materials are handled.

Exposure to fibre dust may cause respiratory disease.

When handling the material, always use approved respiratory protection equipment (RPE-eg. FFP3), eye protection, gloves and long sleeved clothing.

Avoid breaking up waste material. Dispose of waste in sealed containers.

After handling, rinse exposed skin with water before washing gently with soap (not detergent). Wash work clothing separately.

Before commencing any major repairs it is recommended to make reference to the European Association representing the High Temperature Insulation Wool industry (www.ecfia.eu).

Further information can be provided on request. Alternatively, Carbolite Gero Service can quote for any repairs to be carried out either on site or at the Carbolite Gero factory.

6.3 Safety Warning - Molybdenum Disilicide Elements



Molybdenum disilicide elements form a glazed surface when heated. Internal stresses can form through heating and cooling which render the glaze fragile. The glaze can sometimes splinter into a shower of sharp particles when handled. Always wear eye protection when handling the elements.

Handle the heating elements with extreme care as they are very fragile. Also, avoid touching the heating surface (the thin part of the element), as the material is susceptible to corrosive damage from skin contact.

6.4 Temperature Controller Replacement

Refer to the controller instructions for more information on how to replace the temperature controller.

6.5 Fuse Replacement

Fuses are marked on the wiring diagram with type codes, e.g. F1, F2. For more information on fuses refer to section 9.0.

Depending on model and voltage, the different fuse types may or may not be fitted.

If any fuse has failed, it is advisable for an electrician to check the internal circuits.

Replace any failed fuses with the correct type. For safety reasons do not fit larger capacity fuses without first consulting Carbolite Gero.

The fuses are located at the cable entry point. Remove the back panel or control box back panel to gain access to the fuses.

6.6 Thermocouple Replacement

Disconnect the product from the electrical supply and remove the product's element access panel.

Make a note of the thermocouple connections. The negative leg of the thermocouple is marked blue. The "compensating" cable for 1700 & 1800 °C thermocouples is plain copper.

Disconnect the thermocouple from its terminal block.

Bend the metal, or release the thermocouple sheath; withdraw the sheath and shake out any fragments of thermocouple.

Re-assemble with a new thermocouple observing the colour coding. Ensure that the thermocouple is not twisted as it is being inserted and that the metal tag is bent back, or the screw inserted, to grip the sheath.

Refit the product's element access panel.

6.7 Element Protection Tube Option Replacement Procedure

Ensure the furnace is cold and isolated from the electrical connection.

On the underside of the front cowl is a stainless steel mesh, which should be removed for access to the underside of the furnace.

You will see three crescent shaped stainless steel brackets which will support the protection tube once in place; these should be removed by loosening the two screws that hold each of them in place. Care should be taken as insulation may fall if unsupported during the removal of the sections.

Once the insulation sections have been removed, pass the tube up through the hole in the bottom of the furnace and locate within the recess of the furnace roof.

Once correctly located, re-fit the insulation sections and the corresponding brackets.

Re-fit the stainless steel mesh guard to the underside of the furnace.

6.8 Insulation Replacement

After any replacement of insulation material, operate the product at 1500 °C to burn off volatile matter. Do this in a well ventilated area.

6.9 Element Installation and Replacement



See section 6.3 - Safety Warning - molybdenum disilicide.



Molybdenum disilicide elements form a glazed surface when heated. Internal stresses can form through heating and cooling which render the glaze fragile. The glaze can sometimes splinter into a shower of sharp particles when handled. Always wear eye protection when handling the elements.

Handle the heating elements with extreme care as they are very fragile. Also, avoid touching the heating surface (the thin part of the element), as the material is susceptible to corrosive damage from skin contact.

Remove the element access cover (see section 2.1).

Remove the aluminium braids and clips using fingers or the clip tool provided, depending on the type of clip (or remove the combined clips and braids, if supplied). Lift out the old element and the insulation block: handle the block with care as it is fragile. Remove the clamps.

Handle the heating elements with extreme care as they are VERY FRAGILE. Also, avoid touching the heating surface (the thin part of the element).

Carefully unpack the elements and insert them into the insulation blocks. Fix the clamps 45 mm (BLF 17/8) or 30 mm (all other models) from the end of the element as shown in the image below.

Insert the new element; refer to the element connection diagram. Single phase models have all the elements connected in series. Reconnect the braids. Ensure that no braids or clips are touching each other or touching any other furnace parts.

After installing new elements operate the furnace at 1500 °C for an hour. This creates a protective glaze on the element surface.

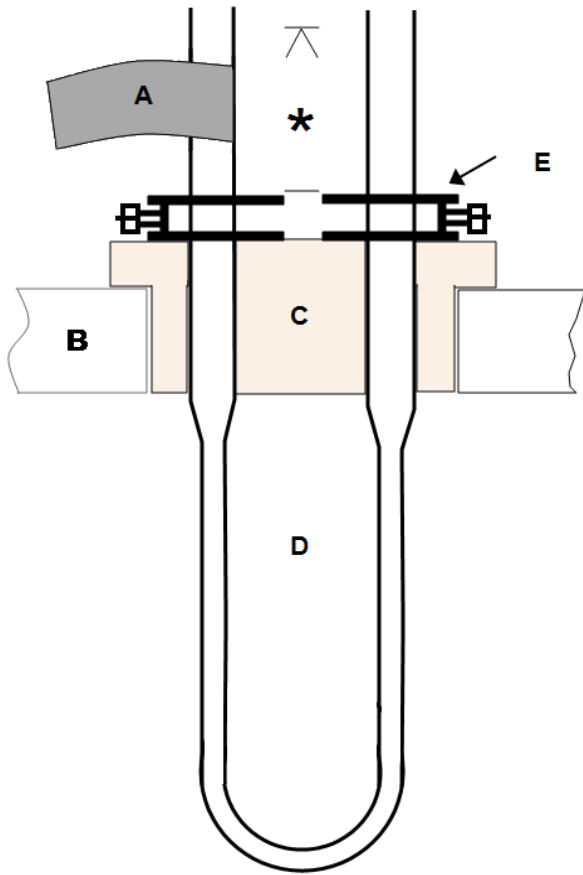

Key	
A	Braid
B	Roof Insulation
C	Element block
D	Element
E	Element Clamp
*	See text



Key	
A	Clip
B	Braid

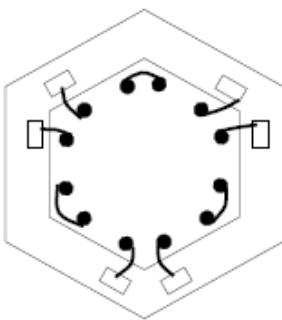

*Element Connections
 (3-phase example)*

Use of Clip Tool

The distance from the top of the element clamp to the top of the element should be 40 mm.

Larger clips require the clip tool, comprising two levers:

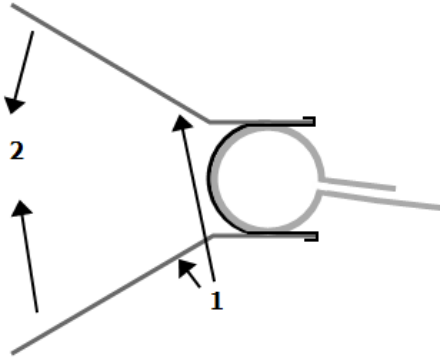

1. Clip tool
2. Apply hand pressure

7.0 Fault Analysis

A. Furnace Does Not Heat Up					
1.	The HEAT light(s) are ON.	▶	An ohm meter applied to the element circuit shows an open circuit.	▶	A heating element has failed.
2.	The HEAT light(s) are OFF.	▶	The controller shows a very high temperature or a code such as S.br.	▶	The thermocouple has broken or has a wiring fault.
		▶	The controller shows a low temperature.	▶	The door switch may be faulty or need adjustment.
				▶	The thyristor fuse may have blown.
				▶	The power thyristor could be failing to switch on due to internal failure, faulty wiring from the controller, or fault controller.
		▶	There are no lights glowing on the controller.	▶	Check the supply fuses and any fuses in the product control compartment.
				▶	The controller may be faulty or not receiving a supply due to a faulty switch or a wiring fault.

B. Product Overheats

1.	The HEAT light goes OFF with the instrument switch.	▶	The controller shows a very high temperature.	▶	The controller is faulty.
		▶	The controller shows a low temperature.	▶	The thermocouple may have been shorted out or may have been moved out of the furnace.
				▶	The thermocouple may be connected the wrong way around.
				▶	The controller may be faulty.
2.	The HEAT light does not go off with the instrument switch and the fault persists when a 2 A control fuse is removed from its fuse-holder.	▶	The power thyristor has failed "ON".	▶	Check for an accidental wiring fault which could have overloaded the thyristor. <i>Isolate the furnace if this fault persists.</i>

8.0 Wiring Diagrams

8.1 215-1-1009

DO NOT SCALE! - IF IN DOUBT ASK DEBURR ALL SHARP EDGES EARTH ALL REMOVABLE PANELS - 1 STUD, 1 PANEL

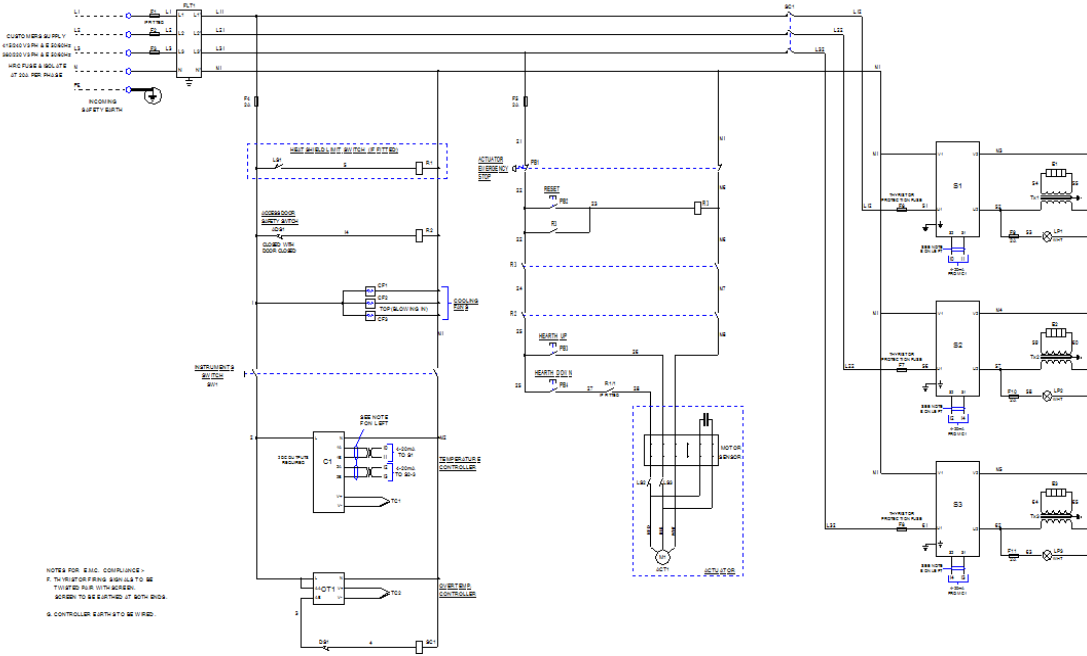

NOTES FOR BNC COMPLIANCE -
 F. THE HORIZONTAL BNC WIRE TO BE TIGHTENED FOR INTERLOCK SCREEN TO BE CLIPPED AT BOTH ENDS
 G. CONTROLLER BNC WIRE TO BE WIPED

CRIMPER NOTES
 1. 2W USE LC POWER + BLACK
 2. 3G CONTROL + RED
 3. 2G CONTROL + PURP/BLUE
 4. 2G/3G USE + PURPLE/BLUE WITH 100V/100V BNC AND 20V/20V USE + PURP/BLUE
 5. ALL INDICATORS + 1.5V BATT BLUE
 6. BATT + GREEN/YELLOW
 7. 1.5V BATT + BROWN/RED ISOLATED WIRE TO BE WHITE

REF	SYMBOL	QTY	DESCRIPTION	MANUFACTURER
1	CB1	1	100A CIRCUIT BREAKER	ABB
2	F1	1	100A FUSE	ABB
3	F2	3	100A FUSE	ABB
4	F3	3	100A FUSE	ABB
5	F4	3	100A FUSE	ABB
6	F5	1	100A FUSE	ABB
7	F6	1	100A FUSE	ABB
8	F7	1	100A FUSE	ABB
9	CB2	1	100A CIRCUIT BREAKER	ABB
10	CB3	1	100A CIRCUIT BREAKER	ABB
11	T1	3	TRANSFORMER	ABB
12	T2	3	TRANSFORMER	ABB
13	T3	3	TRANSFORMER	ABB
14	R1	3	RELAY	ABB
15	R2	3	RELAY	ABB
16	R3	3	RELAY	ABB
17	S1	3	SWITCH	ABB
18	S2	3	SWITCH	ABB
19	S3	3	SWITCH	ABB
20	S4	3	SWITCH	ABB
21	S5	3	SWITCH	ABB
22	S6	3	SWITCH	ABB
23	S7	3	SWITCH	ABB
24	S8	3	SWITCH	ABB
25	S9	3	SWITCH	ABB
26	S10	3	SWITCH	ABB
27	S11	3	SWITCH	ABB
28	S12	3	SWITCH	ABB
29	S13	3	SWITCH	ABB
30	S14	3	SWITCH	ABB
31	S15	3	SWITCH	ABB
32	S16	3	SWITCH	ABB
33	S17	3	SWITCH	ABB
34	S18	3	SWITCH	ABB
35	S19	3	SWITCH	ABB
36	S20	3	SWITCH	ABB
37	S21	3	SWITCH	ABB
38	S22	3	SWITCH	ABB
39	S23	3	SWITCH	ABB
40	S24	3	SWITCH	ABB
41	S25	3	SWITCH	ABB
42	S26	3	SWITCH	ABB
43	S27	3	SWITCH	ABB
44	S28	3	SWITCH	ABB
45	S29	3	SWITCH	ABB
46	S30	3	SWITCH	ABB
47	S31	3	SWITCH	ABB
48	S32	3	SWITCH	ABB
49	S33	3	SWITCH	ABB
50	S34	3	SWITCH	ABB
51	S35	3	SWITCH	ABB
52	S36	3	SWITCH	ABB
53	S37	3	SWITCH	ABB
54	S38	3	SWITCH	ABB
55	S39	3	SWITCH	ABB
56	S40	3	SWITCH	ABB
57	S41	3	SWITCH	ABB
58	S42	3	SWITCH	ABB
59	S43	3	SWITCH	ABB
60	S44	3	SWITCH	ABB
61	S45	3	SWITCH	ABB
62	S46	3	SWITCH	ABB
63	S47	3	SWITCH	ABB
64	S48	3	SWITCH	ABB
65	S49	3	SWITCH	ABB
66	S50	3	SWITCH	ABB
67	S51	3	SWITCH	ABB
68	S52	3	SWITCH	ABB
69	S53	3	SWITCH	ABB
70	S54	3	SWITCH	ABB
71	S55	3	SWITCH	ABB
72	S56	3	SWITCH	ABB
73	S57	3	SWITCH	ABB
74	S58	3	SWITCH	ABB
75	S59	3	SWITCH	ABB
76	S60	3	SWITCH	ABB
77	S61	3	SWITCH	ABB
78	S62	3	SWITCH	ABB
79	S63	3	SWITCH	ABB
80	S64	3	SWITCH	ABB
81	S65	3	SWITCH	ABB
82	S66	3	SWITCH	ABB
83	S67	3	SWITCH	ABB
84	S68	3	SWITCH	ABB
85	S69	3	SWITCH	ABB
86	S70	3	SWITCH	ABB
87	S71	3	SWITCH	ABB
88	S72	3	SWITCH	ABB
89	S73	3	SWITCH	ABB
90	S74	3	SWITCH	ABB
91	S75	3	SWITCH	ABB
92	S76	3	SWITCH	ABB
93	S77	3	SWITCH	ABB
94	S78	3	SWITCH	ABB
95	S79	3	SWITCH	ABB
96	S80	3	SWITCH	ABB
97	S81	3	SWITCH	ABB
98	S82	3	SWITCH	ABB
99	S83	3	SWITCH	ABB
100	S84	3	SWITCH	ABB
101	S85	3	SWITCH	ABB
102	S86	3	SWITCH	ABB
103	S87	3	SWITCH	ABB
104	S88	3	SWITCH	ABB
105	S89	3	SWITCH	ABB
106	S90	3	SWITCH	ABB
107	S91	3	SWITCH	ABB
108	S92	3	SWITCH	ABB
109	S93	3	SWITCH	ABB
110	S94	3	SWITCH	ABB
111	S95	3	SWITCH	ABB
112	S96	3	SWITCH	ABB
113	S97	3	SWITCH	ABB
114	S98	3	SWITCH	ABB
115	S99	3	SWITCH	ABB
116	S100	3	SWITCH	ABB

NOTE
 TRANSFORMER SECONDARY CURRENT TO BE SET TO 12 AMPS FOR BLP175 AND 80A FOR BLP155 USING POT ON INVERTER STACK

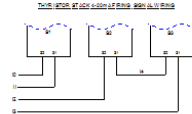

REF	SYMBOL	QTY	DESCRIPTION	MANUFACTURER
1	CB1	1	100A CIRCUIT BREAKER	ABB
2	F1	1	100A FUSE	ABB
3	F2	3	100A FUSE	ABB
4	F3	3	100A FUSE	ABB
5	F4	3	100A FUSE	ABB
6	F5	1	100A FUSE	ABB
7	F6	1	100A FUSE	ABB
8	F7	1	100A FUSE	ABB
9	CB2	1	100A CIRCUIT BREAKER	ABB
10	CB3	1	100A CIRCUIT BREAKER	ABB
11	T1	3	TRANSFORMER	ABB
12	T2	3	TRANSFORMER	ABB
13	T3	3	TRANSFORMER	ABB
14	R1	3	RELAY	ABB
15	R2	3	RELAY	ABB
16	R3	3	RELAY	ABB
17	S1	3	SWITCH	ABB
18	S2	3	SWITCH	ABB
19	S3	3	SWITCH	ABB
20	S4	3	SWITCH	ABB
21	S5	3	SWITCH	ABB
22	S6	3	SWITCH	ABB
23	S7	3	SWITCH	ABB
24	S8	3	SWITCH	ABB
25	S9	3	SWITCH	ABB
26	S10	3	SWITCH	ABB
27	S11	3	SWITCH	ABB
28	S12	3	SWITCH	ABB
29	S13	3	SWITCH	ABB
30	S14	3	SWITCH	ABB
31	S15	3	SWITCH	ABB
32	S16	3	SWITCH	ABB
33	S17	3	SWITCH	ABB
34	S18	3	SWITCH	ABB
35	S19	3	SWITCH	ABB
36	S20	3	SWITCH	ABB
37	S21	3	SWITCH	ABB
38	S22	3	SWITCH	ABB
39	S23	3	SWITCH	ABB
40	S24	3	SWITCH	ABB
41	S25	3	SWITCH	ABB
42	S26	3	SWITCH	ABB
43	S27	3	SWITCH	ABB
44	S28	3	SWITCH	ABB
45	S29	3	SWITCH	ABB
46	S30	3	SWITCH	ABB
47	S31	3	SWITCH	ABB
48	S32	3	SWITCH	ABB
49	S33	3	SWITCH	ABB
50	S34	3	SWITCH	ABB
51	S35	3	SWITCH	ABB
52	S36	3	SWITCH	ABB
53	S37	3	SWITCH	ABB
54	S38	3	SWITCH	ABB
55	S39	3	SWITCH	ABB
56	S40	3	SWITCH	ABB
57	S41	3	SWITCH	ABB
58	S42	3	SWITCH	ABB
59	S43	3	SWITCH	ABB
60	S44	3	SWITCH	ABB
61	S45	3	SWITCH	ABB
62	S46	3	SWITCH	ABB
63	S47	3	SWITCH	ABB
64	S48	3	SWITCH	ABB
65	S49	3	SWITCH	ABB
66	S50	3	SWITCH	ABB
67	S51	3	SWITCH	ABB
68	S52	3	SWITCH	ABB
69	S53	3	SWITCH	ABB
70	S54	3	SWITCH	ABB
71	S55	3	SWITCH	ABB
72	S56	3	SWITCH	ABB
73	S57	3	SWITCH	ABB
74	S58	3	SWITCH	ABB
75	S59	3	SWITCH	ABB
76	S60	3	SWITCH	ABB
77	S61	3	SWITCH	ABB
78	S62	3	SWITCH	ABB
79	S63	3	SWITCH	ABB
80	S64	3	SWITCH	ABB
81	S65	3	SWITCH	ABB
82	S66	3	SWITCH	ABB
83	S67	3	SWITCH	ABB
84	S68	3	SWITCH	ABB
85	S69	3	SWITCH	ABB
86	S70	3	SWITCH	ABB
87	S71	3	SWITCH	ABB
88	S72	3	SWITCH	ABB
89	S73	3	SWITCH	ABB
90	S74	3	SWITCH	ABB
91	S75	3	SWITCH	ABB
92	S76	3	SWITCH	ABB
93	S77	3	SWITCH	ABB
94	S78	3	SWITCH	ABB
95	S79	3	SWITCH	ABB
96	S80	3	SWITCH	ABB
97	S81	3	SWITCH	ABB
98	S82	3	SWITCH	ABB
99	S83	3	SWITCH	ABB
100	S84	3	SWITCH	ABB

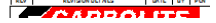

9.0 Fuses and Power Settings

9.1 Fuses

F1 to F3 - Refer to the circuit diagrams.

F1	Internal Supply Fuses	Fitted if supply cable fitted. Fitted on board to some types of EMC filter.	38 mm x 10 mm type F fitted on EMC filter circuit board(s)
F2	Auxiliary Circuit Fuses	Fitted on board to some types of EMC filter. May be omitted up to 25 Amp/phase supply rating.	2 Amps glass type F On board: 20 mm x 5 mm Other: 32 mm x 6 mm
F3	Heat Light Fuses	May be omitted up to 25 Amp/phase supply rating.	2 Amps glass type F 32 mm x 6 mm
	Thyristor Fuse		Ferraz Protistor of the rating shown
	Customer Fuses	Required if no supply cable fitted. Recommended if cable fitted.	See rating label for current; See table below for fuse rating.

Model	Phases	Volts	Supply Fuse Rating	Type	Thyristor Fuse Rating	Current Limit (Element Circuit)
BLF 18/8	3-phase + N	380/220-415/240 V	20 A	Glass	25 A	135 A
BLF 18/8	3-phase Delta	208, 220-240 V	20 A	NS32	25 A	135 A

9.2 Power Settings

The power limit settings (parameter OP.Hi) for this model are voltage dependant. The figures represent the maximum percentage of time that controlled power is supplied to the elements. Do not attempt to "improve performance" by setting a value higher than the recommended values. To adjust the parameter refer to the "Changing the Maximum Output Power" of the control section of the manual.

The setting for the power limit parameter in the controller (OP.Hi) should be 100% for this product.

Please refer to the rating label for product specific information.

Please refer to the rating label for product specific information.

10.0 Specifications

Carbolite Gero reserves the right to change the specification without notice.

Model	Max Temp (°C)	Max Power (kW)	Chamber Size (mm)		Approx. Capacity (l)	Net Weight (kg)
			Height	Diameter		
Bottom Loading Furnaces heated by Molybdenum Disilicide elements, with electrically operated hearth.						
BLF 18/8	1800	7	250	200	8	424

10.1 Environment

The models listed in this manual contain electrical parts and should be stored and used in indoor conditions as follows:

Temperature: 5 °C - 40 °C

Relative humidity: Maximum 80 % up to 31 °C decreasing linearly to 50 % at 40 °C

ProductLabel

The products covered in this manual are only a small part of the wide range of ovens, chamber furnaces and tube furnaces manufactured by Carbolite Gero for laboratory and industrial use. For further details of our standard or custom built products please contact us at the address below, or ask your nearest stockist.

For preventive maintenance, repair and calibration of all furnace and oven products, please contact:

Carbolite Gero Service

Telephone: + 44 (0) 1433 624242

Fax: +44 (0) 1433 624243

Email: ServiceUK@carbolite-gero.com

Carbolite Gero Ltd,

Parsons Lane, Hope, Hope Valley,
S33 6RB, England.

Telephone: + 44 (0) 1433 620011

Fax: + 44 (0) 1433 621198

Email: Info@carbolite-gero.com

www.carbolite-gero.com

CARBOLITE
GERO 30-3000°C

Copyright © 2021 Carbolite Gero Limited